

ESPAÑOL

FRANÇAIS



ENGLISH



marantz®

CD Player
CD5003

User Guide

	CAUTION RISK OF ELECTRIC SHOCK DO NOT OPEN	
CAUTION: TO REDUCE THE RISK OF ELECTRIC SHOCK, DO NOT REMOVE COVER (OR BACK) NO USER-SERVICEABLE PARTS INSIDE REFER SERVICING TO QUALIFIED SERVICE PERSONNEL		

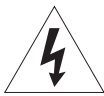

The lightning flash with arrowhead symbol within an equilateral triangle is intended to alert the user to the presence of uninsulated "dangerous voltage" within the product's enclosure that may be of sufficient magnitude to constitute a risk of electric shock to persons.



The exclamation point within an equilateral triangle is intended to alert the user to the presence of important operating and maintenance (servicing) instructions in the literature accompanying the product.

WARNING

TO REDUCE THE RISK OF FIRE OR ELECTRIC SHOCK, DO NOT EXPOSE THIS APPLIANCE TO RAIN OR MOISTURE.

CAUTION: TO PREVENT ELECTRIC SHOCK, MATCH WIDE BLADE OF PLUG TO WIDE SLOT, FULLY INSERT.

ATTENTION: POUR EVITER LES CHOCS ELECTRIQUES, INTRODUIRE LA LAME LA PLUS LARGE DE LA FICHE DANS LA BORNE CORRESPONDANTE DE LA PRISE ET POUSSER JUSQU'AU FOND.

LASER SAFETY

This unit employs a laser. Only a qualified service person should remove the cover or attempt to service this device, due to possible eye injury.

CAUTION : USE OF CONTROLS OR ADJUSTMENTS OR PERFORMANCE OF PROCEDURE OTHER THAN THOSE SPECIFIED HEREIN MAY RESULT IN HAZARDOUS RADIATION EXPOSURE.

IMPORTANT SAFETY INSTRUCTIONS

READ BEFORE OPERATING EQUIPMENT

This product was designed and manufactured to meet strict quality and safety standards. There are, however, some installation and operation precautions which you should be particularly aware of.

1. Read these instructions.
 2. Keep these instructions.
 3. Heed all warnings.
 4. Follow all instructions.
 5. Do not use this apparatus near water.
 6. Clean only with dry cloth.
 7. Do not block any ventilation openings. Install in accordance with the manufacture's instructions.
 8. Do not install near any heat sources such as radiators, heat registers, stoves, or other apparatus (including amplifiers) that produce heat.
 9. Do not defeat the safety purpose of the polarized or grounding-type plug. A polarized plug has two blades with one wider than the other. A grounding type plug has two blades and a third grounding prong. The wide blade or the third prong are provided for your safety. If the provided plug does not fit into your outlet, consult an electrician for replacement of the obsolete outlet.
 10. Protect the power cord from being walked on or pinched particularly at plugs, convenience receptacles, and the point where they exit from the apparatus.
 11. Only use attachments/accessories specified by the manufacturer.
 12. Use only with the cart, stand, tripod, bracket, or table specified by the manufacturer, or sold with the apparatus. When a cart is used, use caution when moving the cart/apparatus combination to avoid injury from tip-over.
- 
13. Unplug this apparatus during lightning storms or when unused for long periods of time.
 14. Refer all servicing to qualified service personnel. Servicing is required when the apparatus has been damaged in any way, such as power-supply cord or plug is damaged, liquid has been spilled or objects have fallen into the apparatus, the apparatus has been exposed to rain or moisture, does not operate normally, or has been dropped.

Additional Safety Information!

- This product should not be placed in a built-in installation such as a bookcase or rack unless proper ventilation is provided or the manufacturer's instructions have been adhered to.
- Apparatus shall not be exposed to dripping or splashing and that no objects filled with liquids, such as vases, shall be placed on the apparatus.
- When the switch is in the OFF position, the apparatus isn't completely switched-off from the MAINS.
- The equipment shall be installed near the power supply so that the power supply is easily accessible.
- Do not expose the unit and batteries to excessive heat such as direct sunlight, fire or the like.
- Make a space of about 4 inches (0.1m) around the unit.

NOTE:

This equipment has been tested and found to comply with the limits for a Class B digital device, pursuant to Part 15 of the FCC Rules. These limits are designed to provide reasonable protection against harmful interference in a residential installation. This equipment generates, uses and can radiate radio frequency energy and, if not installed and used in accordance with the instructions, may cause harmful interference to radio communications. However, there is no guarantee that interference will not occur in a particular installation. If this equipment does cause harmful interference to radio or television reception, which can be determined by turning the equipment off and on, the user is encouraged to try to correct the interference by one or more of the following measures:

- Reorient or relocate the receiving antenna.
- Increase the separation between the equipment and receiver.
- Connect the equipment into an outlet on a circuit different from that to which the receiver is connected.
- Consult the dealer or an experienced radio/TV technician for help.

NOTE:

Changes or modifications may cause this unit to fail to comply with Part 15 of the FCC Rules and may void the user's authority to operate the equipment.

This Class B digital apparatus complies with Canadian ICES-003.

Cet appareil numérique de la Classe B est conforme a la norme NMB-003 du Canada.

DECLARATION OF CONFORMITY

This device complies with Part 15 of the FCC rules. Operation is subject to the following conditions: (1) This device may not cause harmful interference, and (2) this device must accept any interference received, including interference that may cause undesired operation.

**U.S. Responsible Party: Marantz America, Inc.
100 Corporate Drive,
Mahwah, NJ, 07430, U.S.A.
TEL: 201-762-6500**

Type of Product: CD player

Model: CD5003

INTRODUCTION

Thank you for selecting the Marantz CD5003 CD Player for your A/V system.

This Compact Disc Player incorporates a number of features designed to enhance the listening of your favorite audio sources.

Please read these operating instructions carefully. We recommend that you read the entire user guide before you attempt to connect or operate the player.

After you have reviewed the contents of this manual, we suggest that you make all system connections before you attempt to operate the unit.

■ Checking the accessories

After opening the cover of the packing box, check that the following accessories are included.

- Remote controller

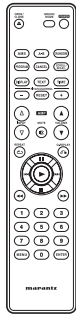

- Size "AAA" batteries x 2

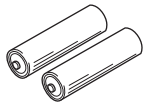

- AC Power cord

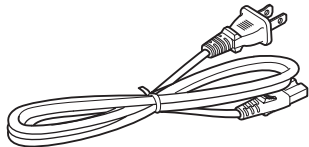

- Audio connecting cord

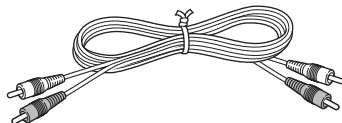

- Remote control connecting cord

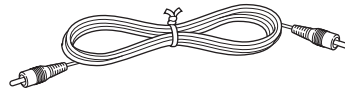

- User Guide

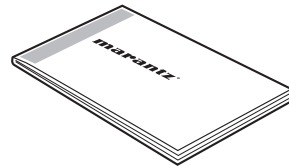

- Warranty Card (USA x 1, Canada x 1)

CONTENTS

FEATURES	2	PROGRAM PLAY (PLAYING TRACKS IN THE PREFERRED SEQUENCE)	16
BEFORE USING	3	DELETE PROGRAM PLAY (PLAY WITH UNDESIRE TRACKS SKIPPED)	17
EQUIPMENT MAINS WORKING SETTING	3	CD-TEXT	20
COPYRIGHT	3	PITCH CONTROL (CHANGING THE PLAY SPEED)	21
INAPPROPRIATE PLACES FOR INSTALLATION	3	PEAK SEARCH (SEARCHING FOR THE LOUDEST PASSAGE)	21
DO NOT PLACE OBJECTS ON TOP	3	EDITING (RECORDING A DISC ON A TAPE)	22
CAUTIONS ON HANDLING MAINS CORD	3	MENU	24
DO NOT ATTEMPT REPAIRS YOURSELF	3	DIGITAL OUTPUT OFF	24
PRECAUTIONS	3	AUDIO EX SELECTION	24
NAMES AND FUNCTIONS	5	PLAYBACK ORDER OF MP3/WMA FILES	25
FRONT PANEL	5	MP3/WMA PLAYBACK MODE SELECTION	26
DISPLAY	6	PLAYING MP3/WMA FILES	26
REMOTE CONTROLLER	7	SELECTING THE FOLDER TO LISTEN TO	26
REAR PANEL	8	PLAYING A SPECIFIC FILE	27
BASIC CONNECTIONS	9	PLAYING A SPECIFIC PART OF A SPECIFIC FILE	27
CONNECTING TO AN AMPLIFIER	9	REPEAT PLAY (PLAYING THE SAME FILES REPEATEDLY)	27
CONNECTING THE POWER SUPPLY	9	RANDOM PLAY (PLAYING FILES IN A RANDOM SEQUENCE)	28
BASIC OPERATIONS –AUDIO CD– 10		AMS PLAY (SEARCHING FOR A SPECIFIC FILE)	29
PLAYING CDS	10	TROUBLESHOOTING	30
PLAYING A SPECIFIC TRACK	10	OTHERS	31
PLAYING A SPECIFIC PART OF A SPECIFIC TRACK	11	NOTES ABOUT THE DISCS	33
ADVANCED CONNECTIONS	12	ABOUT PLAYING COPY-CONTROLLED CDS	33
CONNECTING TO A DIGITAL AUDIO COMPONENT	12		
REMOTE CONTROL CONNECTION	13		
FLASHER INPUT CONNECTOR	13		
ADVANCED OPERATIONS –AUDIO CD– .. 14			
REPEAT PLAY (PLAYING THE SAME TRACKS REPEATEDLY)	14		
RANDOM PLAY (PLAYING TRACKS IN A RANDOM SEQUENCE)	14		
AMS PLAY (SEARCHING FOR A SPECIFIC TRACK)	15		
WHILE PLAYING, REPLAY A SMALL TRACK PORTION AND LISTEN AGAIN (QUICK REPLAY)	15		

FEATURES

- **Using Marantz original HDAM®SA2**

The unit uses an HDAM®SA2, whose quality has been proved in Super Audio CD players and high-end amplifiers, as a high-speed buffer amplifier. You can enjoy the high speed and high-quality sound like that produced by high-end equipment.

- **Incorporates a Cirrus Logic advanced D/A converter, CS4392**

The unit adopts CS4392 corresponding to Cirrus Logic 192 kHz/24 bit in a D/A converter, which is the important element for deciding sound quality, the same with the highly reputed Marantz Super Audio CD player. The Cirrus Logic converter is a high quality device that supports Super Audio CD and DVD-Audio content.

(This model is only suitable for reproduction of Audio CDs or MP3/WMA files)

- **Audio EX function**

Audio EX mode, which allows setting of pitch control, digital output, and display function to OFF, is provided in order for you to enjoy higher quality sound. (page 24)

- **High grade headphone circuit**

The high-grade headphone circuit incorporates a high-speed buffer amplifier to enable headphone listening of high quality sound reproduction, late at night or in other such situations.

- **Supports MP3 and WMA file playback**

MP3 and WMA files that have been recorded onto CD-R or CD-RW discs can be played back on this CD player. (page 25)

- **Pitch control function (Audio CDs only)**

The "pitch control" function enables the play speed (pitch) to be varied over a ± 12 step. (page 21)

- **Quick replay function (Audio CDs only)**

By a single-action operation, the "quick replay" function enables play to be moved back from the current play position for the time equivalent to the setting (setting range: 5 to 60 seconds) and play to be resumed.

This function makes it possible to return to a part of the track that was just played so it can be heard again. (page 15)

- **Supports CD-Text display**

CD-Text is an extension to the existing audio CD standard that enables text information, such as the name of the artist, album title and song titles to be stored on an audio CD.

CDs with the following logos support this function.



Text information is recorded on the parts that are not used in the conventional Audio CDs.

This CD player enables the text information stored on a CD-Text CD to be read (applies only to English alphanumeric text).

BEFORE USING

This section must be read before any connection is made to the mains supply.

EQUIPMENT MAINS WORKING SETTING

Your Marantz product complies with the household power and safety requirements in your area. This product can be powered by 120 V AC only.

COPYRIGHT

Recording and playback of any material may require consent. For further information refer to the following:

- Copyright Act 1956
- Dramatic and Musical Performers Act 1958
- Performers Protection Acts 1963 and 1972
- any subsequent statutory enactments and orders

INAPPROPRIATE PLACES FOR INSTALLATION

To keep your player in perfect working order for the longest possible time, avoid installing the player in the following locations.

- Wherever it will be exposed to direct sunlight
 - Wherever it will be close to a heater or other heat-radiating appliance
 - Wherever the humidity is high or ventilation is poor
 - Wherever it is very dusty
 - Wherever it will be subject to vibration
 - On top of a rickety stand or in an unstable location which is tilted at an angle
 - On top of an amplifier or other component which dissipates a great deal of heat
 - In an audio rack with little space at the top and bottom or other location where the heat dissipation will be obstructed
- To ensure proper heat dissipation, install the player while leaving clearances between the player and wall or other components, as shown in the figure below.

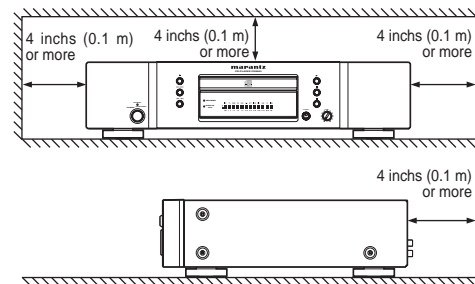

DO NOT PLACE OBJECTS ON TOP

- Refrain from placing any objects on top of the player.

CAUTIONS ON HANDLING MAINS CORD

- Do not touch the mains cord with wet hands.
- When disconnecting the mains cord, always make sure that you take hold of the plug. Yanking out or bending the cord can damage it and/or cause electric shocks or a fire.
- Get into the habit of disconnecting the power plug before leaving home.

DO NOT ATTEMPT REPAIRS YOURSELF

- Refrain from lubricating the player: doing so can cause malfunctioning.
- Only qualified engineers with specialized expertise are authorized to repair the pick-up and parts inside the player.

PRECAUTIONS

- In winter, droplets of water form on the insides of the windows of a heated room: this is called condensation. This CD player uses an optical lens, so the condensation may form in the following cases.
 - In a room immediately after the heating has been turned on
 - In a room where the humidity level is high
 - When the player has been suddenly brought from a cold location into a warm room

Since, in cases like this, the track numbers may not be read and the player is prevented from operating properly, wait about 30 minutes, and then operate the player.
- This player may cause interference on a tuner or TV set. If this is the case, place it further away from the tuner or TV set.
- Compact discs have much less noise than analog records and hardly any noise is heard before play starts. Bear in mind, therefore, that if the volume control on the amplifier is set too high, you will risk damaging other audio components.
- This audio player is for the exclusive playing of Audio CDs (Compact Discs) and MP3/WMA compressed data files.

It cannot play CD-ROMs used with personal computers, game CDs, video CDs, DVDs (video/audio) or DTS-CDs.
- We do not recommend the use of lens cleaners.

BEFORE USING

■ Loading batteries

Before using the remote controller for the first time, load the batteries in the remote controller. The batteries provided are used to verify the operations of the remote controller only.

- 1 Remove the battery cover.

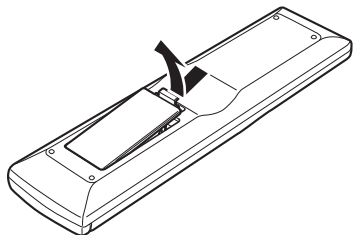

- 2 Insert the batteries with correct +/- orientation.

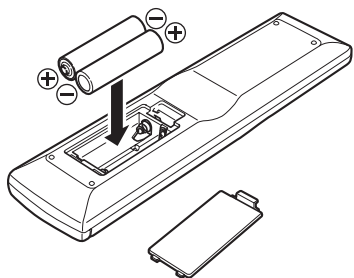

- 3 Close the battery cover until it clicks shut.

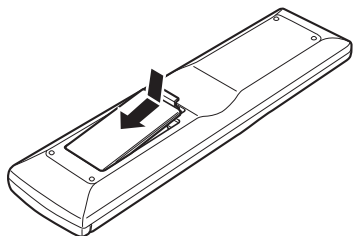

■ Cautions on handling batteries

Misuse of the batteries can result in electrolyte leakage, rupturing, corrosion, etc. Bear in mind the following points when using batteries.

- Remove the batteries from the remote control unit if the unit is not going to be used for a prolonged period (a month or more).
- Do not use an old battery together with a new one.
- Insert the batteries while ensuring that their \oplus and \ominus poles are properly aligned with the corresponding markings on the remote control unit.
- Batteries with the same shape may have different voltages. Do not use different types of batteries together.
- If electrolyte has leaked, thoroughly wipe the inside of the battery compartment, and then insert new batteries.
- When batteries which are no longer required are to be discarded, follow the directions (regulations) laid down by the local authorities in the area concerned for their disposal.

■ Usage of remote controller

Operational range

Operate the unit with the remote controller within the range of the illustration below.

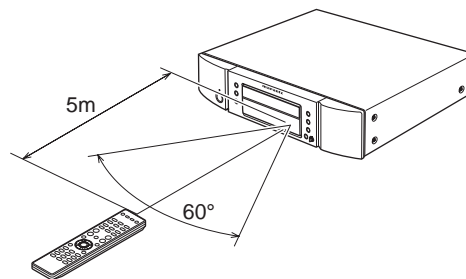

Precautions

- Do not allow direct sunlight, an inverter fluorescent light or other strong source of light to shine onto the player's infrared signal reception window (remote sensor). Otherwise, the operation of the remote control unit may be disabled.
- Bear in mind that operating the remote control unit may cause other devices operated by infrared rays to be operated by mistake.
- The remote control unit cannot be operated if the space between the controller and the player's remote sensor is obstructed.
- Do not place any objects on top of the remote control unit. Doing so may cause one or more buttons to be held down which will cause the batteries to run down.

NAMES AND FUNCTIONS

FRONT PANEL

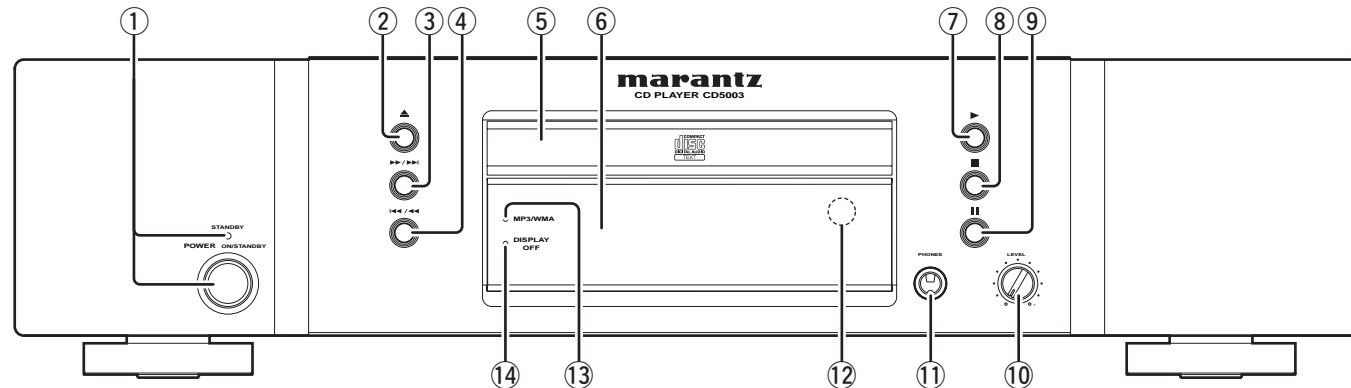

① POWER ON/STANDBY switch and Standby indicator

This is used to turn the player's power ON and STANDBY. When it is pressed, the display lights and the power is turned on; when it is pressed again, the power is turned off and STANDBY indicator lights.

② ▲ (OPEN/CLOSE) button

This is used to open and close the disc tray. When it is pressed, the disc tray opens; when it is pressed again, it closes.

③ ►►/►►| (search forward/next track) button

The same number of tracks as the number of times the button is pressed are skipped in the forward direction. When the button is held down, tracks are searched (fast forward).

④ ◀◀/◀◀ (previous track/search backward) button

When this button is pressed, play returns to the start of the track now being played. The same number of tracks as the number of times the button is pressed can be skipped in the reverse direction. When the button is held down, tracks are searched (fast backward).

⑤ Disc tray

This is where the CD to be played is placed.

⑥ Display

This shows the settings, play status, text information, etc.

⑦ ► (PLAY) button

This is used to start play.

⑧ ■ (STOP) button

This is used to stop play.

⑨ || (PAUSE) button

This is used to temporarily suspend play.

⑩ PHONES LEVEL control

This is used to adjust the headphones volume level. The level increases when it is turned clockwise.

⑪ PHONES jack

The headphones are connected to this jack. Use headphones that come with a standard plug.

⑫ Remote sensor

This senses the infrared control signals sent from the remote control unit.

⑬ MP3/WMA Indicator

This lights up when an MP3/WMA file is being played.

⑭ DISPLAY OFF indicator

This lights in the DISPLAY OFF mode (when the display is off).

NAMES AND FUNCTIONS

DISPLAY

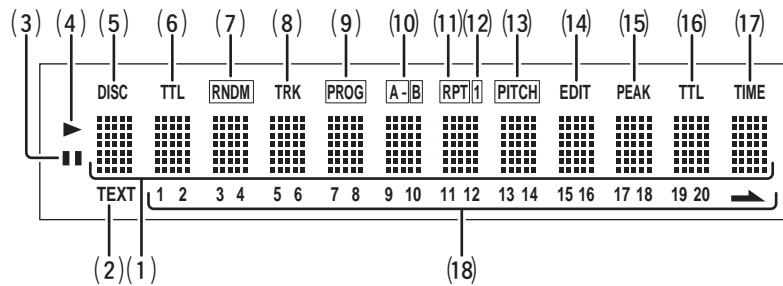
**(1) Main display**

This displays the time information and text information of the disc played, the setting menu, etc.

(2) TEXT indicator

This lights when a disc supporting CD-TEXT has been loaded.

(3) II (pause) indicator

This lights when play is temporarily suspended.

(4) ► (play) indicator

This lights during play.

(5) DISC indicator

This flashes during readout of the table of contents (TOC) information on the disc.

(6) TTL (total track) indicator

This lights above the display of the total number of tracks recorded on the disc.

(7) RNDM (random) indicator

This lights during random play.

(8) TRK (track) indicator

This lights above the display of the number of the track being played, etc.

(9) PROG (program) indicator

This lights during program play.

(10) A-B (A-B repeat) indicator

This lights during A-B repeat play.

(11) RPT (repeat) indicator

This lights up or flashes when the playback is set to REPEAT.

(12) 1 (1-track repeat) indicator

This lights during 1-track repeat play.

(13) PITCH (pitch control) indicator

Lights up when the pitch control function is set and active.

(14) EDIT indicator

This lights during edit mode.

(15) PEAK indicator

This lights during peak search and playback of the peak.

(16) TTL (total time) indicator

When the total remaining time or total program time is displayed, this lights above that display.

(17) TIME indicator

This lights while the elapsed time or other such time is displayed.

(18) 1 - 20, ➡ (music calendar)

This displays the track numbers recorded on the disc, the track numbers still to be played, and the track numbers programmed for program play. (Audio CD only)

NAMES AND FUNCTIONS

REMOTE CONTROLLER

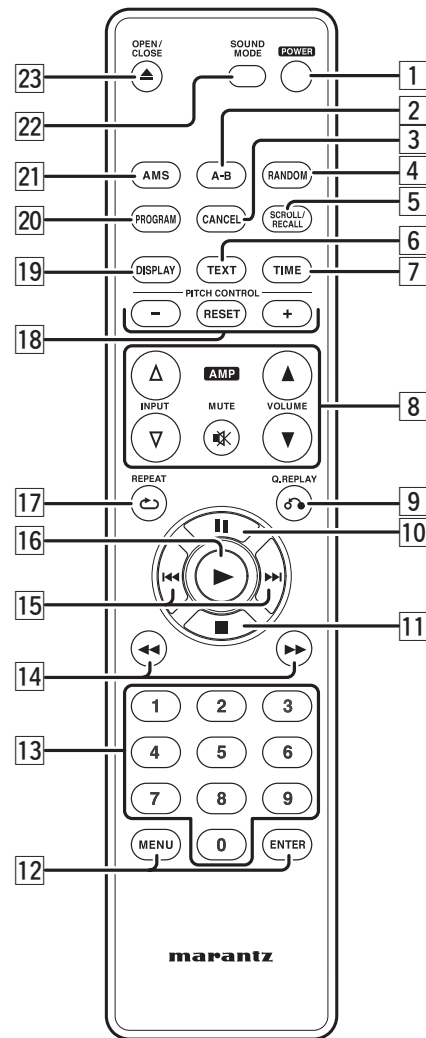

1 POWER button

This is used to switch the player's power ON and STANDBY. (page 10)

2 A-B (A-B repeat) button

This is used to set start point (A) and end point (B) when a particular section is to be played repeatedly. (page 14, 28)

3 CANCEL button

This is used to cancel the programmed tracks. (page 18, 19)

4 RANDOM button

This is used to play the tracks in a random sequence. (page 14, 28)

5 SCROLL/RECALL button

This is used to scroll the text display when text is displayed. When it is pressed during program play, it is possible to check which tracks have been programmed. (page 19)

6 TEXT button

This is used to switch the main display from the time display to the text display. (page 20, 25, 17)

7 TIME button

This switches the main display from the text display to the time display. It can also switch the time display during play. (page 17)

CD:

It can display how much time has elapsed and how much play time remains for the current track as well as how much play time remains for the whole disc.

MP3/WMA:

The elapsed time and time remaining for the file can be displayed.

8 ▲, ▼ (volume) button △, ▽ (input) button MUTE button

These are used to operate the corresponding functions of a Marantz integrated amplifier. For details, refer to User Guide supplied with the Integrated Amplifier.

9 Q. REPLAY button

Jump back a set time before the current playing position and resume play. (page 15)

10 || (pause) button

This is used to temporarily suspend play.

11 ■ (stop) button

This is used to stop the play.

12 MENU, ENTER button

MENU button:

This button displays the various settings. (page 23)

ENTER button:

Saves the current settings.

13 Numeric buttons (0 to 9)

These are used to specify the numbers of the tracks to be played.

14 ◀◀, ▶▶ (search) buttons

◀◀ : This button is used to search backward when it is held down during play.

▶▶ : This button is used to search forward when it is held down during play.

15 ◀◀◀, ▶▶▶ (track skip) buttons

◀◀◀ : Use this to return to the start of the track now playing or return to the start of the previous track.

▶▶▶ : Use this to advance to the start of the subsequent track.

16 ▶ (play) button

This is used to start play.

17 REPEAT button

This is used to play one track or all the tracks on the disc repeatedly. (page 14, 27, 28)

18 PITCH -/RESET/+ (pitch control down/reset/up) buttons

These are used to adjust the play speed (pitch) with a ± 12 step. (Audio CD only) (page 21) These buttons are also used to select MP3/WMA folders. (page 26)

19 DISPLAY button

This is used to turn off the display (DISPLAY OFF mode). (The display is turned off only during play.)

20 PROGRAM button

This is pressed to initiate program play. (page 16)

21 AMS (auto music scan) button

This is used to play the intros of all the tracks in sequence starting from the first track for the duration equivalent to the setting. (page 15)

22 SOUND MODE button

This is used to switch Audio EX mode (page 24), and to set use of pitch control (page 21).

23 ▲ OPEN/CLOSE button

This is used to open and close the disc tray. When it is pressed, the disc tray opens; when it is pressed again, it closes.

NAMES AND FUNCTIONS

REAR PANEL

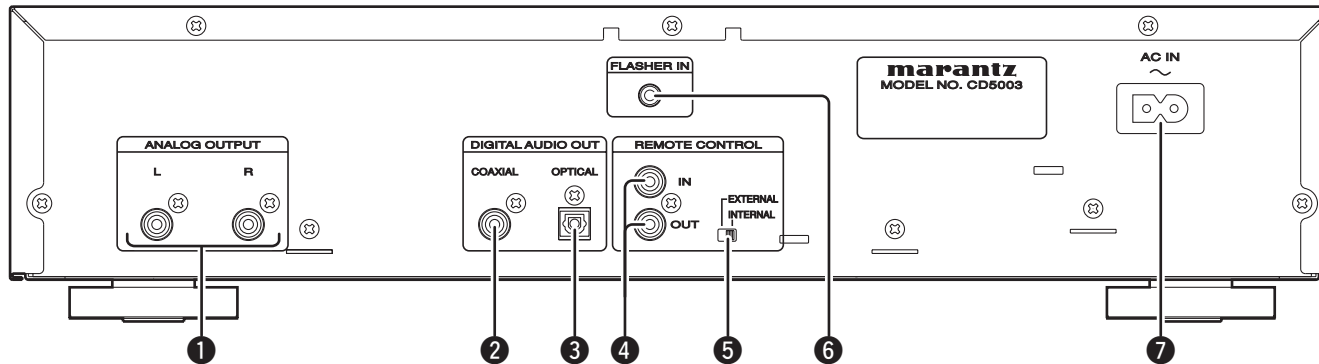

1 ANALOG OUT (analog output) connectors

The music signals during play are output from these connectors.

2 DIGITAL AUDIO OUT COAXIAL (digital coaxial output) connector

The music signals during play are output digitally from this coaxial output connector.

Note:

- Digital signals are not output at some settings. For details, see "DIGITAL OUTPUT OFF" and "AUDIO EX SELECTION" (page 24).

3 DIGITAL AUDIO OUT OPTICAL (digital optical output) connector

The music signals during play are output digitally from this optical output connector.

Note:

- Digital signals are not output at some settings. For details, see "DIGITAL OUTPUT OFF" and "AUDIO EX SELECTION" (page 24).

4 REMOTE CONTROL IN and OUT connectors

Using the supplied remote control connecting cable, these connectors enable this player to be connected to a Marantz component equipped with remote control connectors. These connections make it possible to control an entire system that centers on the amplifier or other such component.

5 EXTERNAL/INTERNAL switch

The switch is set to INTERNAL, when first purchased, enabling the player's built-in signal reception window to be used. Before using the supplied connecting cable to make the connection between the player and the remote control connectors on a Marantz equipment, set the switch to EXTERNAL.

Note:

Signals cannot be received from the remote control unit if the switch is kept at EXTERNAL when the player is to be used on its own.

6 Flasher input connector

This is used to control this unit using a keypad from another room.

7 Power cord connector socket

Use the supplied power cord to connect to a standard household power supply outlet.

Connect the player so that the power cord can be removed easily as a precaution against possible accidents.

BASIC CONNECTIONS

This CD player is connected to an amplifier, CD recorder and other components for use. To ensure that the components are connected properly, refer to the instruction manuals that come with the components to be connected.

Before connecting the components, be absolutely sure to turn off their power.

CONNECTING TO AN AMPLIFIER

Use the audio connecting cord to connect the audio player with a stereo amplifier or AV amplifier. When making the connections, insert the plugs securely into the connectors. Failure to insert the plugs securely may result in noise.

Note:

Do not connect the player to the PHONO input connectors on the amplifier.

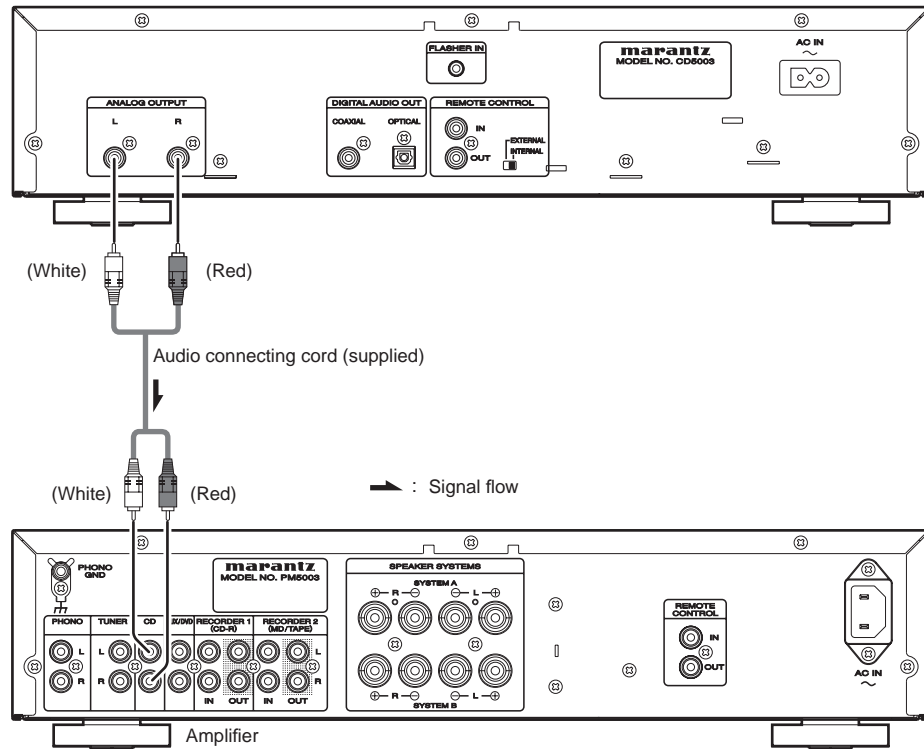

CONNECTING THE POWER SUPPLY

1. Plug the power cord into AC IN jack on the back panel.

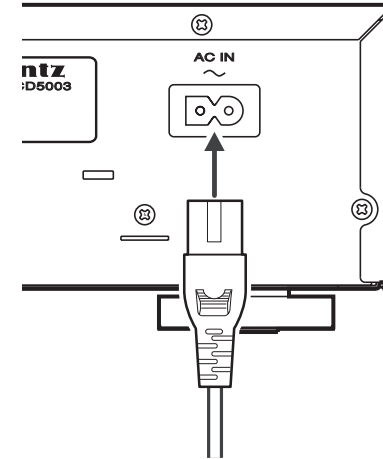

2. Turn on the power switch of the audio unit (amplifier, etc.) that is connected with this unit. Set the selector on the connected unit to this unit.
3. Plug the power cord into an AC outlet.

BASIC OPERATIONS –AUDIO CD–

PLAYING CDS

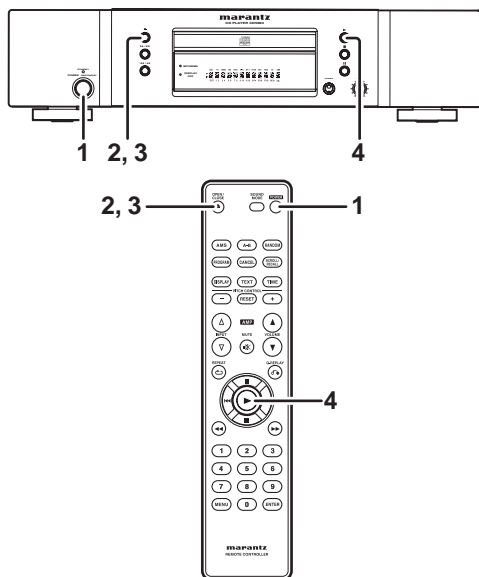

1. Press the POWER button on the player or on the remote controller to turn on the power.
2. Press the ▲ button on the player or on the remote controller. Place the CD to be played in the extended disc tray while ensuring that the label with the printed text is facing up.

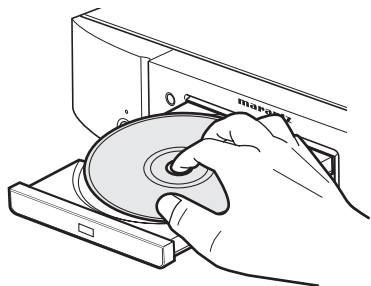

In the case of a single (8 cm) CD, align it with the indentation in the center of the tray.

3. Press the ▲ button to retract the disc tray. Once the disc tray has been retracted, "TOC Reading" appears on the display, after which the total number of CD tracks and total playing time are displayed. In the case of a disc that supports CD-TEXT, the album title is displayed, and then the total number of CD tracks and total playing time are displayed.
4. Press the ► button on the player or remote control unit to start play. Adjust the volume level at the amplifier.

■ Pausing play

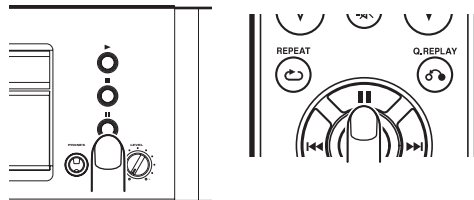

During play, press the || button on the player or remote control unit to temporarily suspend play. To resume play from the place where it was temporarily suspended, press the ► button or || button on the player or the ► button or || button on the remote control unit.

■ Stopping play

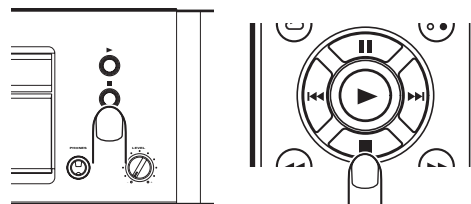

Press the ■ button on the player or remote control unit during play.

■ Removing the CD

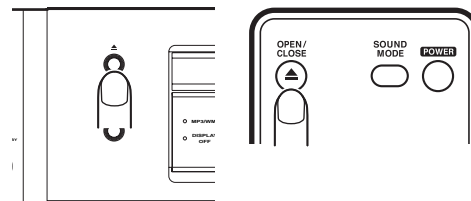

After play has finished, press the ▲ button on the player or on the remote controller to extend the disc tray, and remove the CD. After the CD has been removed, press the ▲ button again to retract the disc tray. The disc tray should always be retracted when the player is not in use.

PLAYING A SPECIFIC TRACK

■ Specifying the number of a track to be played (direct search)

Select the number of the track to be played directly by pressing the numeric buttons (0 to 9) on the remote control unit.

To select track number 10 or above, use the numeric buttons to select the higher digit first and then select the lower digit.

Once the number of the track is selected, play will start automatically.

Example: To play track 3

Press the "3" numeric button.

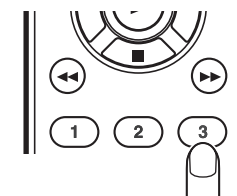

Example: To play track 12

Press the "1" numeric button.

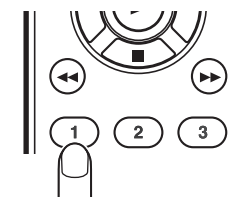

Within 1.5 second, press the "2" numeric button.

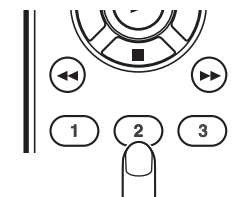

BASIC OPERATIONS –AUDIO CD–

■ Playing a previous or subsequent track (track skip)

Advancing to a subsequent track

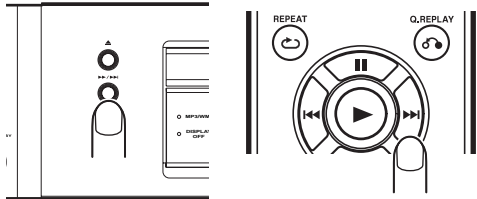

Press the ►►/►► button on the player or ►► button on the remote control unit for the number of times equivalent to the number of tracks through which play is to be advanced.

Returning to the start of the track now playing or a previous track

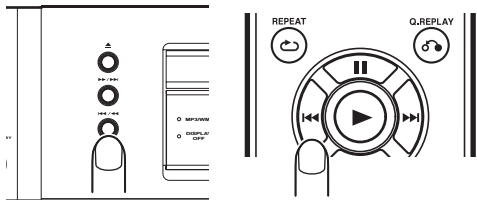

When the ◀◀/◀◀ button on the player or ◀◀ button on the remote control unit is pressed, play returns to the start of the track now playing. Play returns to the previous track which is equivalent to the number of times the button was pressed.

PLAYING A SPECIFIC PART OF A SPECIFIC TRACK

■ Searching a specific part of a track (search)

While listening to a track being played, it is possible to search a specific part of that track by a forward or backward search.

Forward searching through the track now playing

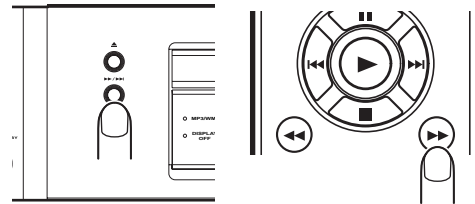

The search (forward search) mode is established by holding down the ►►/►► button on the player or ►► button on the remote control unit. Holding down the button initiates a forward search.

Backward searching through the track now playing

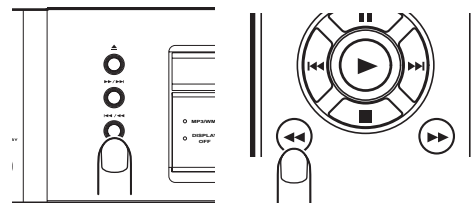

The search (backward search) mode is established by holding down the ◀◀/◀◀ button on the player or ◀◀ button on the remote control unit. Holding down the button initiates a backward search. (Returns during backward searches are not constant.)

ADVANCED CONNECTIONS

CONNECTING TO A DIGITAL AUDIO COMPONENT

The player has one digital optical output connector and one digital coaxial output connector.
You can enjoy digital recording when the player is connected to a CD recorder or other digital recording component.

■ Connecting the optical output connector

Use an optical digital connecting cable available on the market. Insert the plug firmly in until it clicks into place. Do not bend or bundle the optical digital connecting cable.

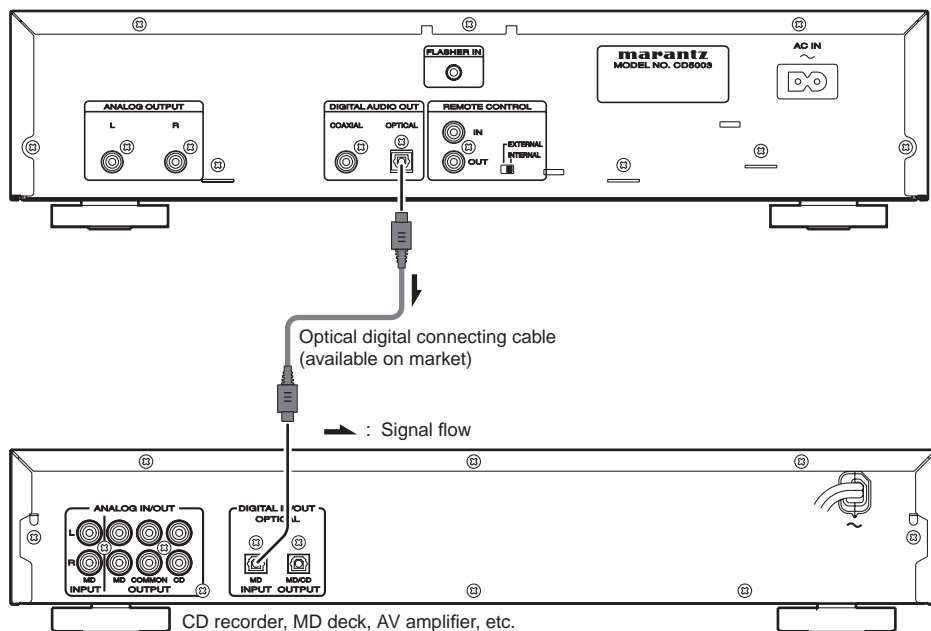

■ Connecting the coaxial output connector

Use a coaxial digital connecting cable available on the market.

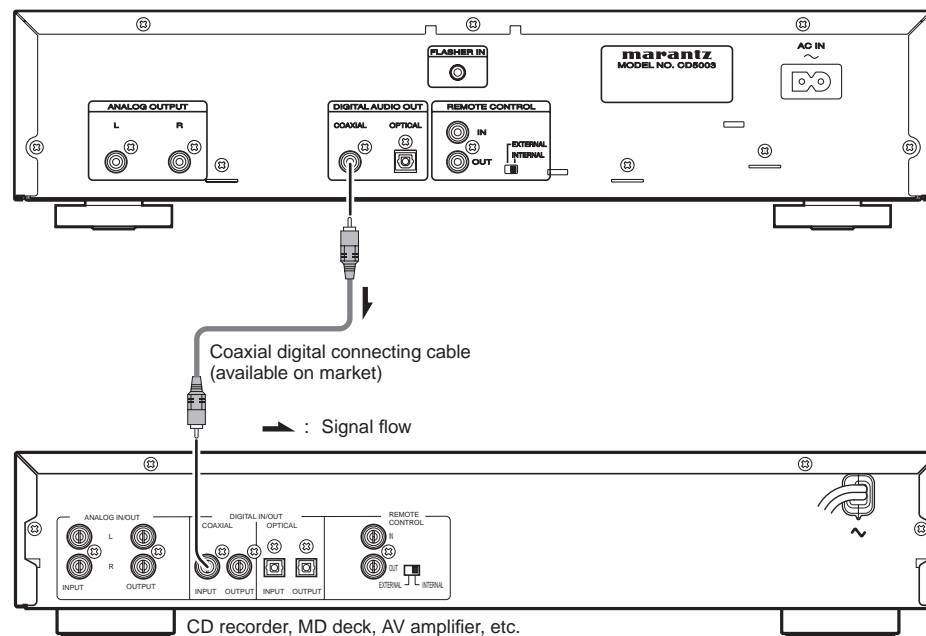

ADVANCED CONNECTIONS

REMOTE CONTROL CONNECTION

By using the remote control cord provided, connecting this player to additional Marantz audio equipment enables the connected equipment to be remote controlled as a single audio system.

- When connecting equipment incorporating a remote sensor, connect the “remote control out” connector of the equipment to the “remote control in” jack of the CD player.

When doing this, set this player’s switch to “EXTERNAL.” This will stop its remote control IR receiver from operating and the player can now be controlled via the remote control IR receiver of the attached equipment.

- When using this CD player alone, set the switch to “INTERNAL.”

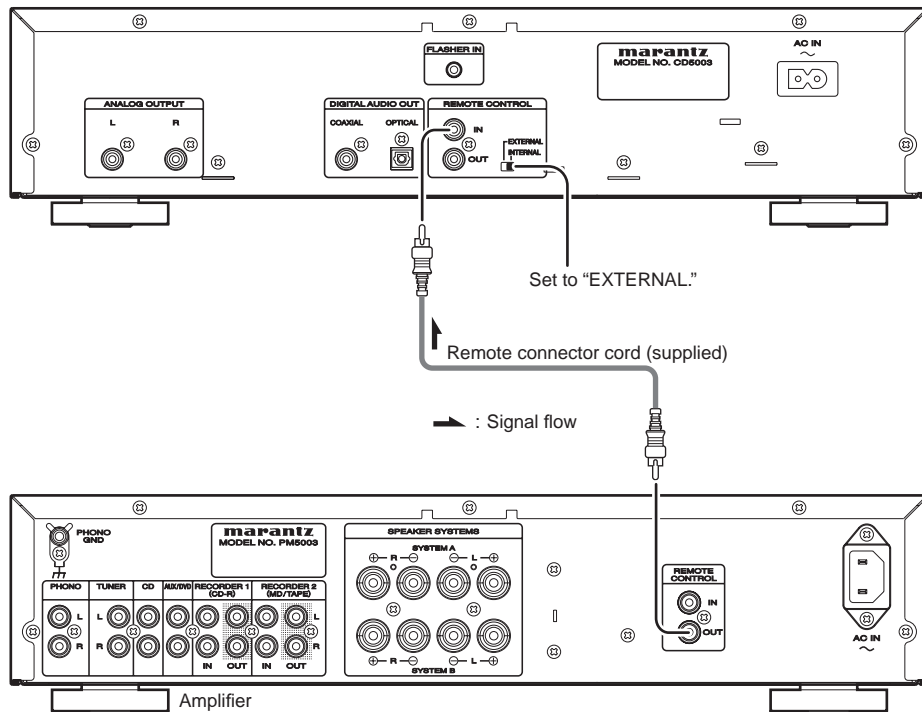

FLASHER INPUT CONNECTOR

- This is used to control this unit using a keypad from another room. Set this switch to “EXT.”
- If a flasher input connector is to be used, do not use the remote control input connector.

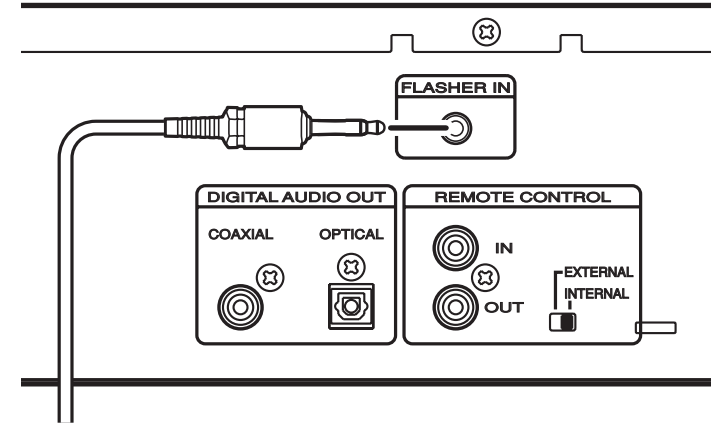

ADVANCED OPERATIONS –AUDIO CD–

REPEAT PLAY (PLAYING THE SAME TRACKS REPEATEDLY)

■ Playing all tracks repeatedly (all-track repeat)

This function repeatedly plays all the tracks. Repeat play is possible even during random play or program play.

Press the REPEAT button on the remote control unit.

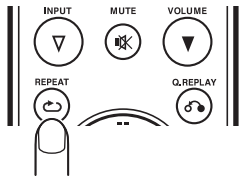

The "RPT" indicator on the display lights, and the repeat play of all the tracks starts.

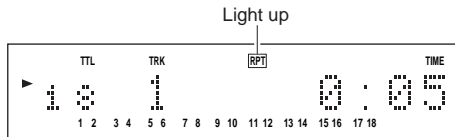

To stop all-track repeat play and resume normal play, press the REPEAT button on the remote control unit twice. The "RPT" indicator on the display goes off.

■ Playing one track repeatedly (1-track repeat)

This function repeatedly plays one track only. Even during random play or program play, it repeats the track being played.

Press the REPEAT button on the remote control unit twice while the track to be repeated is playing.

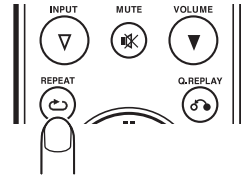

The "RPT" and "1" indicators light, and track now playing is repeated.

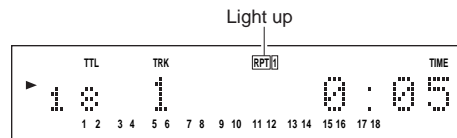

To stop 1-track repeat play and resume normal play, press the REPEAT button on the remote control unit to turn off the "RPT" indicator on the display.

■ Playing a specific part repeatedly (A-B repeat)

This function repeatedly plays a specific part of a track that you want to hear.

1. During play, press the A-B button on the remote control unit at the start point of the part to be repeated.

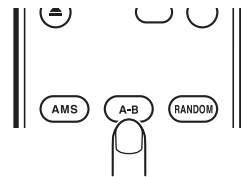

The "A-" indicator on the display now lights.

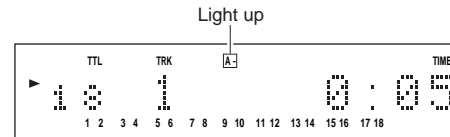

2. Press the A-B button on the remote control unit at the end point of the part to be repeated.

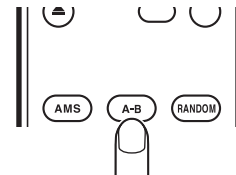

The "A-B" indicator on the display now lights, and the designated part (from point A to point B) is played repeatedly.

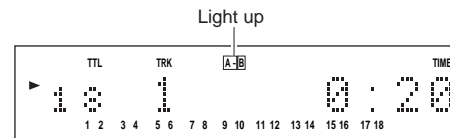

To stop A-B repeat play and resume normal play, press the A-B button on the remote control unit to turn off the "A-B" indicator on the display.

Note:

The A-B repeat play function cannot be used during random play.

RANDOM PLAY (PLAYING TRACKS IN A RANDOM SEQUENCE)

This function rearranges the tracks into a random sequence and it then plays all the tracks in this random sequence. If it is used together with repeat play, the same tracks can be repeatedly played but in a different sequence every time.

During play or stop, press the RANDOM button on the remote control unit.

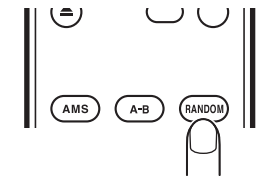

The items on the music calendar appear on the display one after the other, and the "RNDM" indicator lights.

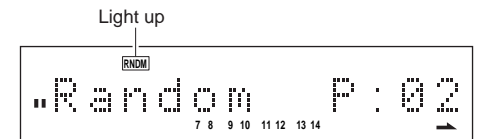

Random play now starts.

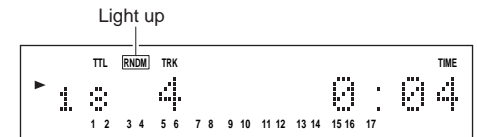

To stop random play and resume normal play, press the RANDOM button on the remote control unit. The "RNDM" indicator on the display goes off.

ADVANCED OPERATIONS –AUDIO CD–

■ **Skipping tracks during random play to search other tracks**

When the ►►/►► button on the player or ►► button on the remote control unit is pressed during random play, the next track is selected at random and played.

Conversely, when the ◀◀/◀◀ button on the player or ◀◀ button on the remote control unit is pressed during random play, play returns to the start of the track now playing.

AMS PLAY (SEARCHING FOR A SPECIFIC TRACK)

All track intros, from the first track onward, are played back in sequence, which is useful when searching for a desired track.

You can choose whether to play 10, 20 or 30 seconds of each track.

During stop or play, press the AMS (auto music scan) button on the remote control unit.

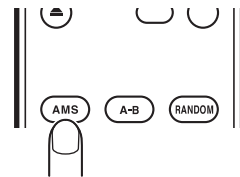

Press the AMS button repeatedly to switch through the different scan modes.

“Scan 10”, “Scan 20”, “Scan 30”, “Scan Off”.. (Scan Off aborts the scan function) light on the display, and the “►” indicator flashes.

Flashes

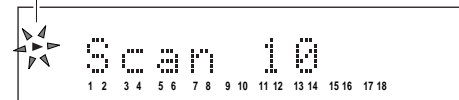

All track intros, from the first track onward, are played back in sequence, for the amount of time they have been preset (10 sec. when first purchased).

Flashes

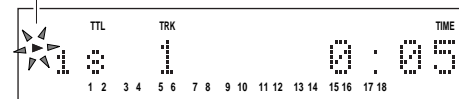

Once the track you want to hear has been found, press the ► button. The “►” indicator now lights, and the track found and whatever comes after that track will now be played normally.

When the RANDOM button on the remote control unit is pressed during AMS play, the AMS play function is released, and the random play mode is established.

WHILE PLAYING, REPLAY A SMALL TRACK PORTION AND LISTEN AGAIN (QUICK REPLAY)

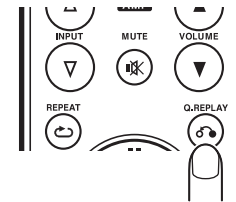

If the Q.REPLAY button is pressed during playback, the play position will jump back by the length of time set in MENU, and then resume.

Note:

Jump back cannot go beyond the beginning of the current track.

When the Q.REPLAY button is pressed, if the total length of the track being played is shorter than the time set for quick replay, or if the track elapsed playing time is shorter than the time set for quick replay, the play position will return to the beginning of the track and resume playing.

How to set the Quick Replay time

1. If there is a disc in the disc tray, remove the disc and close the tray.
2. Press the MENU button on the remote controller once then the ■ button four times.

The display will indicate “Quick Replay.”

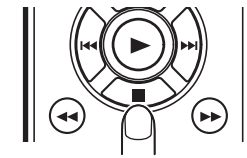
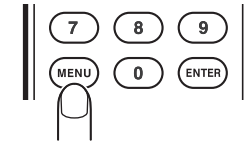

3. Press the ENTER button of the remote control.

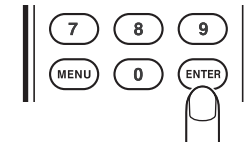

The currently time setting will be displayed (at the time of purchase, this is set to 10 seconds).



ADVANCED OPERATIONS –AUDIO CD–

4. Set the desired time with the ◀◀ or ▶▶ buttons (5 - 60 s).



5. After setting the time, press the ENTER button. The display will return to normal.

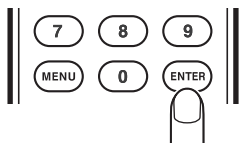

Note:

- If there is a period of more than 4 seconds during this procedure in which a key is not pressed, the setting at that time will be set, and the display will return to displaying the time.

PROGRAM PLAY (PLAYING TRACKS IN THE PREFERRED SEQUENCE)

The order in which the CD tracks are played can be rearranged into the sequence desired. Up to 30 tracks can be programmed.

■ Program play in the time display mode

In the case of a CD-TEXT disc, first press the TIME button on the remote control unit to set the main display to the time display mode.

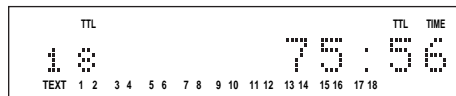
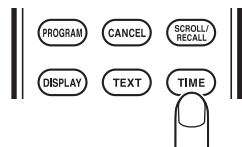

1. During stop, press the PROGRAM button on the remote control unit.

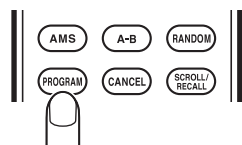

"Program" appears for an instant on the main display.

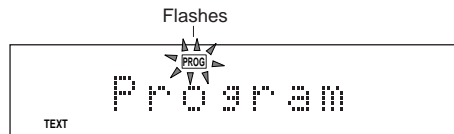

The PROG indicator flashes, and the program mode is established.

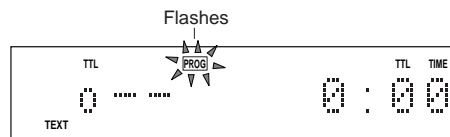

2. Press the numeric buttons on the remote control unit the tracks can also be selected using the ◀◀ and ▶▶ buttons on the remote control unit or ◀◀◀◀ and ▶▶▶▶ buttons on the player. To select track number 10 or above, use the numeric buttons to select the higher digit first and then select the lower digit.

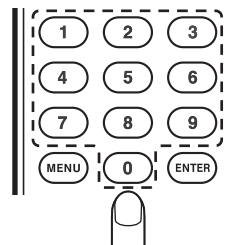

Display example: When track 2 has been selected

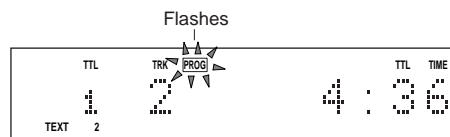

3. Repeat step 2 to program the desired tracks in sequence. At each step of the programming, the number of tracks programmed and their total time appear on the main display. Up to 30 tracks can be programmed.

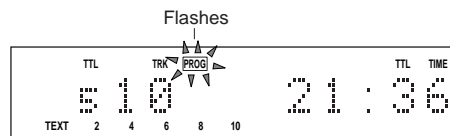

4. Once all the tracks have been programmed, press the ■ button on the player or remote control unit or press the PROGRAM button on the remote control unit.

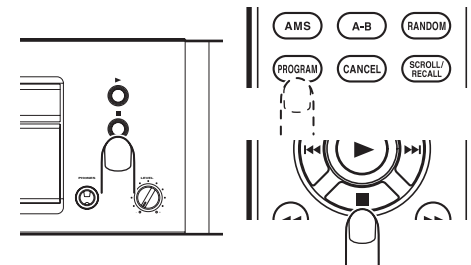

The PROG indicator stops flashing and lights up instead, and the program is entered.

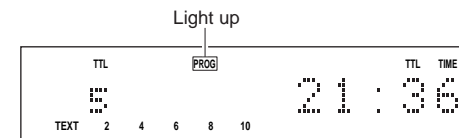

5. Press the ▶ button on the player or remote control unit. Play now starts in the programmed sequence.

Program play will start even when step 4 is omitted.

NAMES AND FUNCTIONS

BASIC CONNECTIONS

BASIC OPERATIONS

ADVANCED CONNECTIONS

ADVANCED OPERATIONS

TROUBLESHOOTING

OTHERS

ADVANCED OPERATIONS –AUDIO CD–

■ Program play in the text display mode

In the case of a CD-TEXT disc, tracks can be selected by title for program play.

If the main display is set to the time display mode, press the TEXT button on the remote control unit to establish the text display mode.

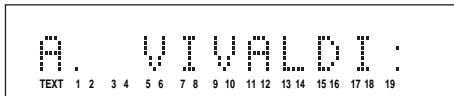
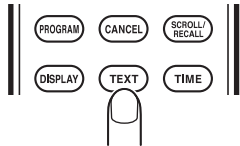

1. During stop, press the PROGRAM button on the remote control unit.

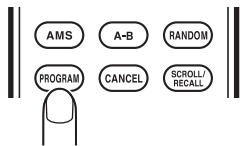

“Program” appears for an instant on the main display. Then the PROG indicator flashes, and the program mode is established.

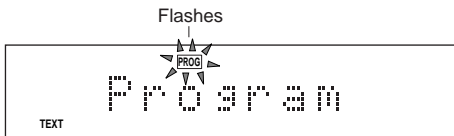

2. Press the ◀◀ and ▶▶ buttons on the remote control unit or ◀◀/▶▶ and ▶▶/▶▶ buttons on the player to select the track. (The track can also be selected using the numeric buttons on the remote control unit but in this case the title is not displayed).

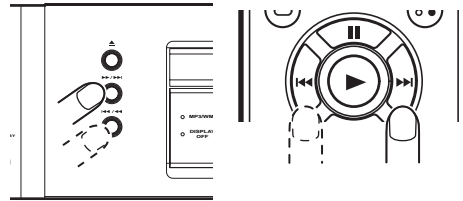

The title of each selected track is scrolled, and once it has been scrolled, it is programmed automatically. If you do not want to program the track, select another track before the scrolling is completed.

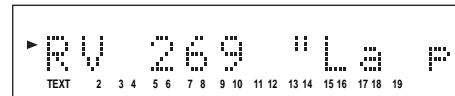

3. Repeat step 2 to program the desired tracks in sequence. Up to 30 tracks can be programmed.

4. Once all the tracks have been programmed, press the ■ button on the player or remote control unit or press the PROGRAM button on the remote control unit.

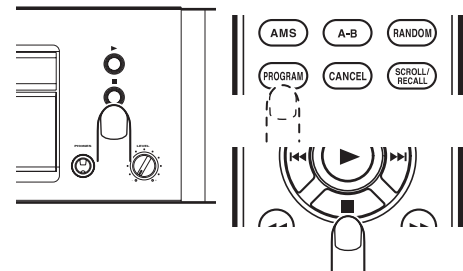

The PROG indicator stops flashing and lights up instead, and the program is entered.

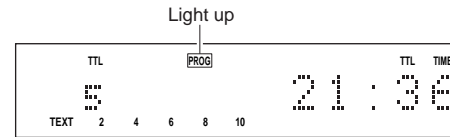

5. Press the ▶ button on the player or remote control unit. Play of the selected tracks now starts in the programmed sequence.

Program play will start even when step 4 is omitted.

Note:

Programming in the text display mode cannot be performed for tracks which have no text information for their titles.

DELETE PROGRAM PLAY (PLAY WITH UNDESIRE TRACKS SKIPPED)

This function makes it possible to skip those tracks that you do not want to hear during CD play. Up to 30 tracks can be deleted from the program.

■ Delete program play in the time display mode

In the case of a CD-TEXT disc, first press the TIME button on the remote control unit to set the main display to the time display mode.

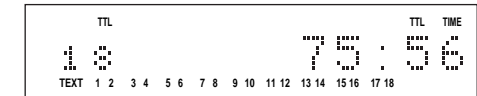
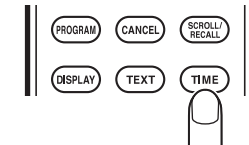

1. During stop, press the PROGRAM button on the remote control unit, and then press the CANCEL button.

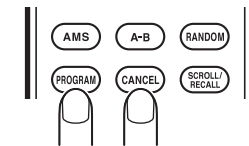

“Delete Prog.” appears for an instant on the main display.

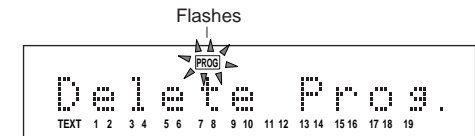

ADVANCED OPERATIONS –AUDIO CD–

The total number of CD tracks and the total play time appear on the main display, the PROG indicator flashes, and the delete program mode is established.

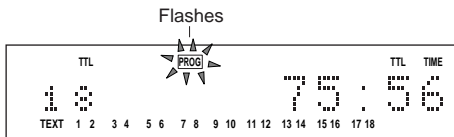

2. Press the numeric buttons on the remote control unit that you do not want to hear (the track can also be selected using the **◀◀** and **▶▶** buttons on the remote control unit or **◀◀/▶▶** and **▶▶/▶▶** buttons on the player).

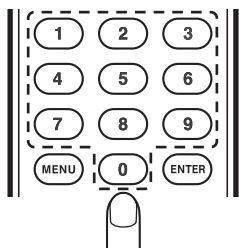

Display example: When track 2 has been selected

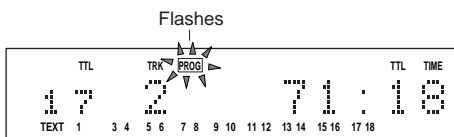

3. Repeat step 2, and upon completion of the programming, press the **■** button on the player or remote control unit or press the PROGRAM button on the remote control unit.

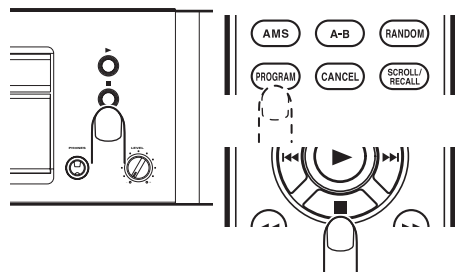

The PROG indicator in the display stops flashing and lights up instead, and the delete program is entered. Up to 30 tracks can be deleted from the program.

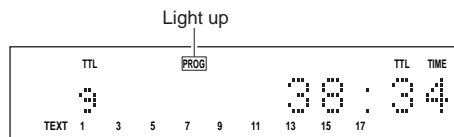

4. Press the **▶** button on the player or remote control unit. The CD is now played but with the deleted tracks skipped.

■ Delete program play in the text display mode

In the case of a CD-TEXT disc, the tracks that are not desired can be selected by title for delete program play.

If the main display is set to the time display mode, press the TEXT button on the remote control unit to establish the text display mode.

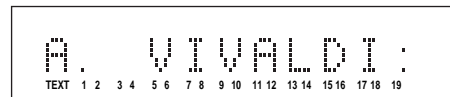
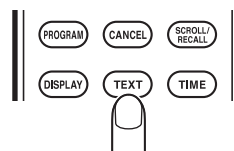

1. During stop, press the PROGRAM button on the remote control unit, and then press the CANCEL button.

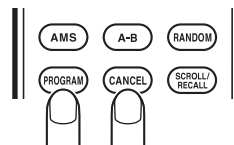

“Delete Prog.” appears for an instant on the main display.

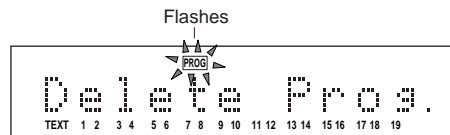

The total number of CD tracks and the total playing time appear on the main display, the PROG indicator flashes, and the delete program mode is established.

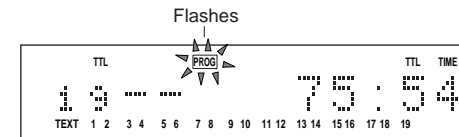

2. Press the **◀◀** and **▶▶** buttons on the remote control unit or **◀◀/▶▶** and **▶▶/▶▶** buttons on the player to select the track which you do not want to hear. (The tracks can also be selected using the numeric buttons on the remote control unit but in this case the titles will not be displayed.)

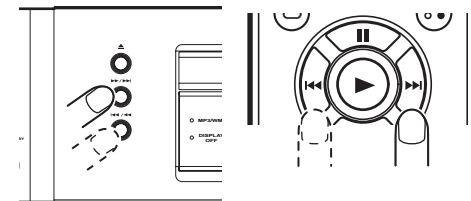

The title of each selected track is scrolled, and once it has been scrolled, it is deleted automatically. If you do not want to delete the track, select another track before the scrolling is completed.

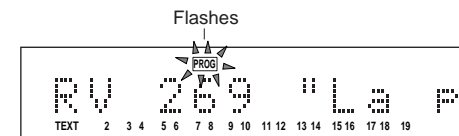

ADVANCED OPERATIONS –AUDIO CD–

- Repeat step 2, and upon completion of the programming, press the **■** button on the player or remote control unit or press the PROGRAM button on the remote control unit.

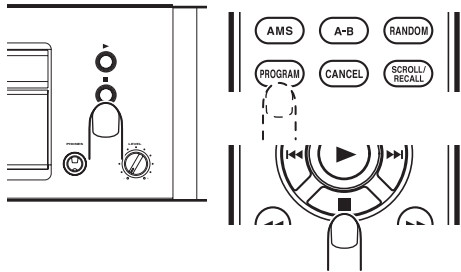

The PROG indicator in the display stops flashing and lights up instead, and the delete program is entered. Up to 30 tracks can be deleted from the program.

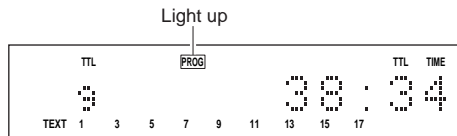

- Press the **▶** button on the player or remote control unit. The CD is now played but with the deleted tracks skipped.

Note:

Delete programming in the text display mode cannot be performed for tracks which have no text information for their titles.

■ Checking the program or delete program contents

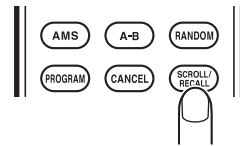

During programming operation or program play, press the SCROLL/RECALL button on the remote control unit.

With program play, the programmed tracks are displayed one after the other in sequence on the main display.

With delete program play, the deleted tracks are displayed one after the other in sequence on the main display.

■ Changing the program or delete program contents

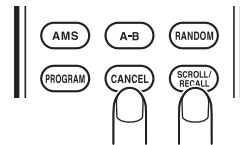

Deleting tracks which were programmed for program play

When the SCROLL/RECALL button on the remote control unit is pressed during programming, the programmed tracks are displayed one after the other in sequence.

As soon as the track to be deleted from the program has appeared, press the CANCEL button on the remote control unit immediately. The number of the deleted track is cleared from the music calendar on the display.

Canceling the deletion of tracks which were deleted for delete program play

When the SCROLL/RECALL button on the remote control unit is pressed during delete programming, the deleted tracks are displayed one after the other in sequence.

As soon as the track whose deletion is to be canceled has appeared, press the CANCEL button on the remote control unit immediately. The number of the track whose deletion was canceled is displayed in the music calendar on the display.

■ Adding tracks to the program

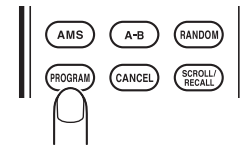

Press the PROGRAM button on the remote control unit during stop. The status of the PROG indicator in the display changes from lighted to flashing, and more tracks can be added to the program.

■ Returning program play to normal play (canceling the entire program)

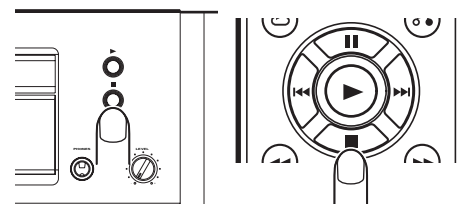

Press the **■** button on the player or remote control unit twice during program play or once during stop. The PROG indicator on the display goes off, and the entire program is canceled.

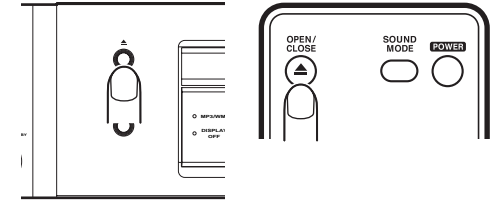

Alternatively, a program can be canceled when the disc tray is opened by pressing the **▲** button on the player or on the remote controller.

■ Precautions for program and delete program play

- When using the numeric buttons to select tracks 1 to 9 on a CD with 10 or more tracks in total, allow 1.5 seconds or so to elapse after the button corresponding to the number of the previous track was pressed before pressing the button corresponding to the number of the next track.
- When using the numeric buttons to select track 10 or up on a CD with 10 or more tracks in total, press the button corresponding to lower digit within 1.5 seconds or so after the button corresponding to the higher digit was pressed.
- When using the **◀◀** and **▶▶** buttons for programming, keep pressing one of these buttons with less than half a second or so in between until the number of the desired track is displayed.
- If the total time for a program exceeds 99 minutes 59 seconds, the time display will appear as “--:--”.

ADVANCED OPERATIONS –AUDIO CD–

CD-TEXT

The text information recorded on a CD-TEXT disc can be viewed on this player. In the case of a CD-TEXT CD, the display window will light up as shown in the diagram below. The maximum of characters that can be displayed is 64.

Display of player

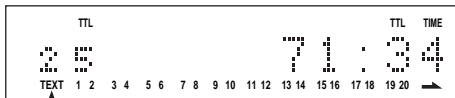

This lights when the disc that has been read is identified as supporting CD-TEXT.

When the TEXT button on the remote control is pressed, the CD-TEXT information will be displayed as outlined in the diagram on the right.

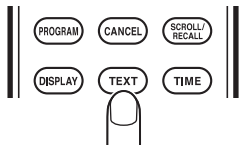

However, the recorded information differs from one disc to another so that not all the information given below will necessarily be displayed. Items not recorded are automatically omitted and skipped by the player, and only the existing items are displayed.

■ During play

Each time the TEXT button on the remote control unit is pressed, the information items are displayed in the following sequence. During play, the information of track now playing is mainly displayed.

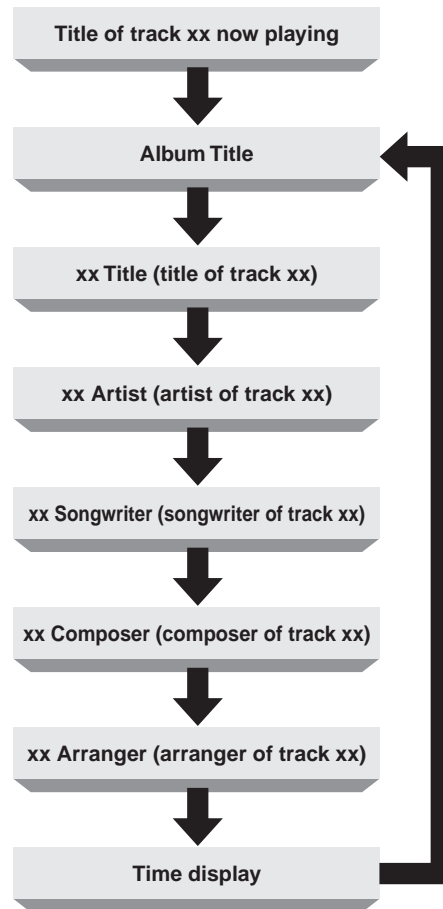

■ In the stop mode

Each time the TEXT button on the remote control unit is pressed, the information items are displayed in the following sequence. When the ► button is pressed while "-- Title" is displayed, the track concerned starts playing.

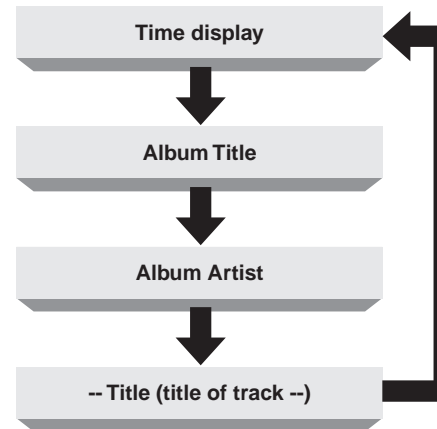

ADVANCED OPERATIONS –AUDIO CD–

PITCH CONTROL (CHANGING THE PLAY SPEED)

During stop, press the SOUND MODE button on the remote controller several times until "Audio EX OFF" appears on the display.

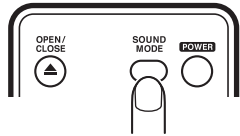

The play speed (pitch) can be changed across a ± 12 step.

Note:

Digital signals are not output during pitch control. (Signals are output when the pitch control is set to 0).

Increasing the play speed

Press the PITCH+ button on the remote control unit.

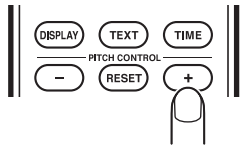

"PITCH" will light up and each time the button is pressed, the playback speed will increase (max +12).

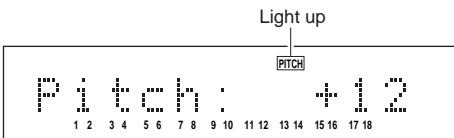

Reducing the play speed

Press the PITCH- button on the remote control unit.

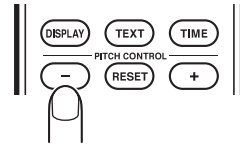

"PITCH" will light up and each time the button is pressed, the playback speed will decrease (min -12).

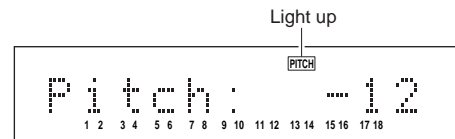

Returning play to the normal speed

Press the PITCH RESET button on the remote control unit.

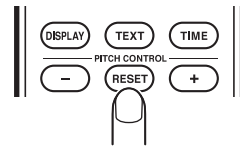

The "PITCH" indicator on the display goes off and "Pitch: 0" appears on the main display. If the PITCH RESET button on the remote control unit is pressed again, play returns to the previous speed setting.

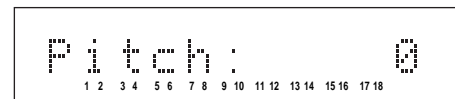

PEAK SEARCH (SEARCHING FOR THE LOUDEST PASSAGE)

If the cassette deck recording level is adjusted in relation to the peak level on the disc, it is possible to avoid distortion and noise in recording. This facility allows the peak over the entire disc or in the programmed to be detected before proceeding to editing.

1. With the player at stop, press the MENU button on the remote control once. "Peak" will be displayed.

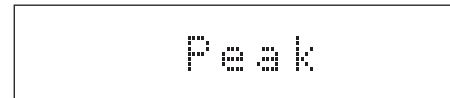
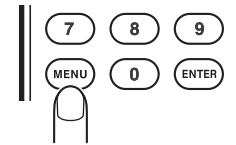

2. Press the ENTER button on the remote control.

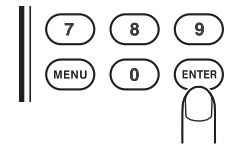

"PEAK" will light up and the peak search operation will begin from the first passage on the disc.

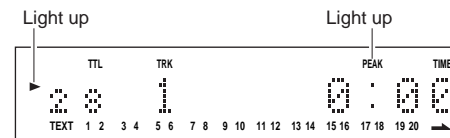

3. When peak search of the last passage is completed, play will be repeated for approximately 6 seconds with the volume at a comparatively high level. Adjust the record level of the cassette deck. (Please see the instruction manual for the cassette deck.)

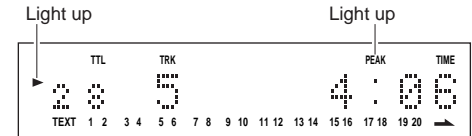

4. Press the ■ button on the player or remote control unit to stop the peak search operation.

Note:

As a CD may contain several peaks, a different peak may be found every time the auto peak level search operation is performed.

ADVANCED OPERATIONS –AUDIO CD–

EDITING (RECORDING A DISC ON A TAPE)

When recording from a compact disc to a tape, use this function to match the tape length to the playing time of the tracks to be recorded and to create 4-second intervals between the tracks.

Simple edit

This operation fits tracks into a specified tape length while keeping the tracks in their original order.

1. During stop, press the MENU button on the remote controller then the button. "Edit" appears.

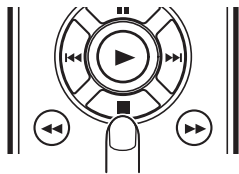
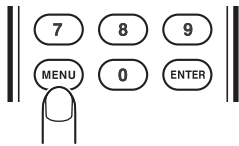

2. Press the ENTER button on the remote control.

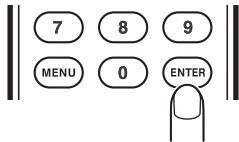

"EDIT" will light up, the player will enter edit mode, and the tracks will be divided up into SIDE A and SIDE B.

(Example: When a disc with 28 tracks is loaded)

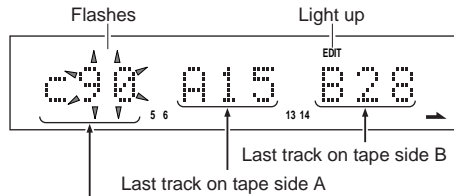
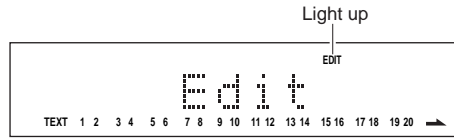

The tape recording time display (90) appears.

This example shows that, when the tape recording time is 90 minutes, track 15 is the last track on tape side A and track 28 the last track on tape side B. In other words, by using a 90-minute tape, all of the 28 disc tracks can be accommodated by assigning tracks 1 to 15 on tape side A and tracks 16 to 28 on tape side B.

3. To change the tape recording time, specify the new tape recording time using the or button or the numeric buttons (0 to 9).

• Use of and buttons

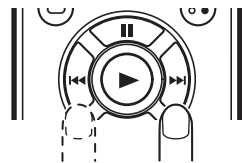

Each press of the button allows you to change the recording time in the order 90 → 46 → 54 → 60 → 74 → 90.

Each press of the button allows you to change the recording time in the order 90 → 74 → 60 → 54 → 46 → 90.

• Use of and buttons

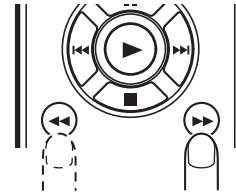

Each press of the button allows you to increase the recording time by 1 minute.

Each press of the button allows you to decrease the recording time by 1 minute.

• Using the numeric buttons

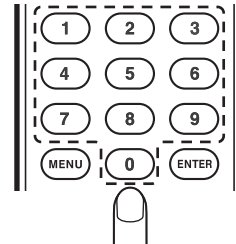

When numeric buttons are used to specify a C-46 tape, for example, press 4 then 6.

The arrow mark will flash. (indicates that tracks after 17 will not be played.)

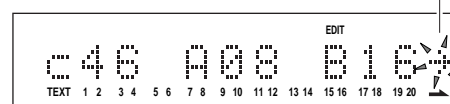

This display example shows that, with a 46-minute tape, tracks 1 to 8 will be recorded onto tape side A and tracks 9 to 16 will be recorded onto tape side B.

The blinking arrow on the right end of the character display shows that tracks 17 and after cannot be recorded on the tape.

4. Press the ENTER button again and set the editing contents.

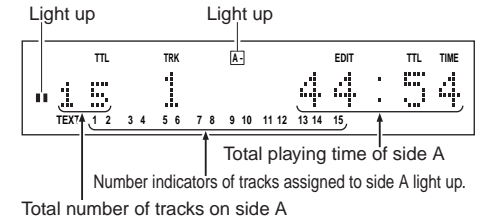

Total playing time of side A
Number indicators of tracks assigned to side A light up.
Total number of tracks on side A

5. Start playing in accordance with "Edit recording" (page 23).

ADVANCED OPERATIONS –AUDIO CD–

■ Program edit

This procedure allows you to record tracks in any desired order while fitting the tracks into a specified tape length.

1. Program tracks according to "PROGRAM PLAY" (page 16).
2. The rest of the program edit procedure is the same as step 1 to 4 in the simple edit procedure.

■ Delete program edit

When recording from a disc to a tape, this procedure allows you to omit the tracks you do not want to record, while fitting the tracks into a specified tape length.

1. Program tracks according to "DELETE PROGRAM PLAY" (page 17).
2. The rest of the delete program edit procedure is the same as step 1 to 4 in the simple edit procedure.

Note:

- During a simple edit, program edit or delete program edit, only STOP, OPEN/CLOSE or POWER ON/STANDBY button operations can be performed. (Remote-controlled operation is not possible)

This is intended to prevent mistakes in recording due to erroneous operation.

- The display is always in the time display mode during edit play. It is not possible to switch to the text display mode.

■ Edit recording

– Recording to a cassette deck

1. After setting up, setup the cassette deck to rec pause state.
2. Press ► or || buttons of the player to start A side program. The player sends out signal to start recording and starts playing A side program after 4 seconds.

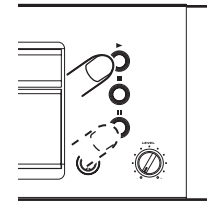

3. After A side program complete, player turns to the pause state at the beginning of B side program.
4. Turn the cassette tape over and start recording.
5. Press ► or || buttons of the player manually to start B side recording. Player sends out signal to restart recording and starts playing B side program after 4 seconds.

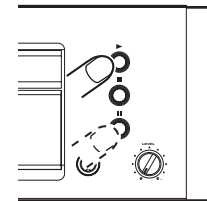

6. After B side program complete, player stops playing and clears edit program automatically.

ADVANCED OPERATIONS

MENU

The following functions can be selected and set. During stop, press the MENU button on the remote controller. Press the ■ or ■■ button on the remote controller to select the desired item.

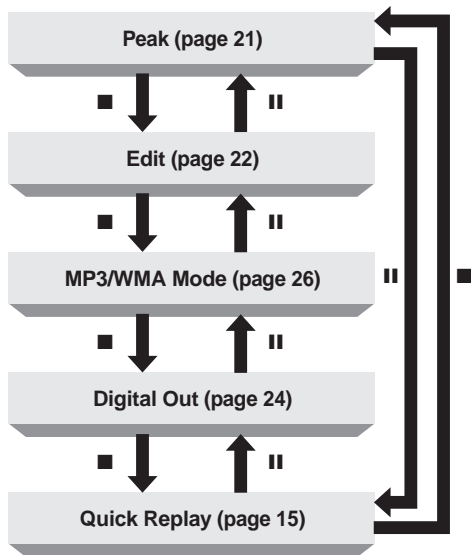

DIGITAL OUTPUT OFF

If digital output is not to be used, turn digital output OFF, and you can enjoy higher-quality sound.

■ Setting digital output ON or OFF

1. During stop, press the MENU button on the remote controller once then the ■ button three times. "Digital Out" appears.

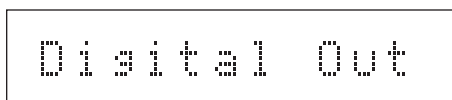
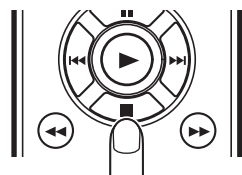
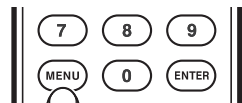

2. Press the ENTER button on the remote controller.

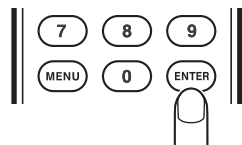

The current settings appear on the display.
(At the factory, digital output is set to ON.)

3. Press the ►►/◄◄ buttons to switch digital output ON or OFF.
4. Press the ENTER button after making a setting.
Normal display is resumed.

AUDIO EX SELECTION

For higher-quality sound, select the Audio EX setting, referring the table below. Audio EX changes as shown below each time the SOUND MODE button on the remote controller is pressed during stop.

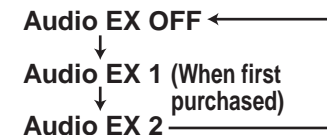

Sound mode	Pitch control	Digital output	Display
Audio EX OFF: A digital signal is output only when the pitch control setting is 0.	Usable	Yes (*1) (when the pitch control setting is 0)	Yes
Audio EX 1: When first purchased. Audio EX 1 offers better sound.	Not usable	Yes (*1)	Yes
Audio EX 2: Audio EX 2 offers best sound from analog outputs.	Not usable	No	No (during play) (*2)

(*1) Setting of Digital Out on the MENU (page 24) takes priority.

(*2) Pressing the DISPLAY button on the remote controller shows the display for three seconds.

ADVANCED OPERATIONS – MP3, WMA FILES –

PLAYBACK ORDER OF MP3/WMA FILES

● Example of MP3/WMA playback order

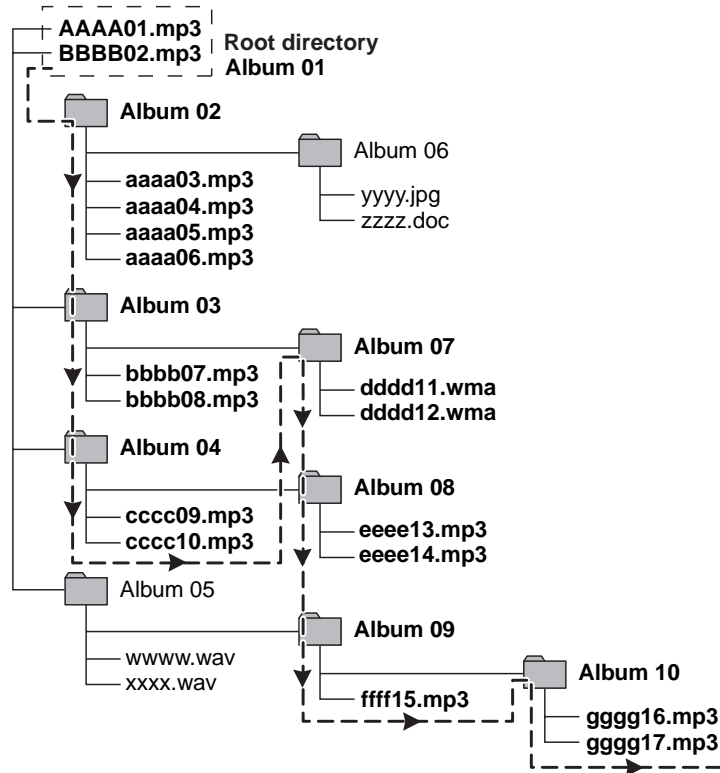

● Playback order

- | | | |
|--------------|---------------|---------------|
| 1 AAAA01.mp3 | 7 bbbb07.mp3 | 13 eeee13.mp3 |
| 2 BBBB02.mp3 | 8 bbbb08.mp3 | 14 eeee14.mp3 |
| 3 aaaa03.mp3 | 9 cccc09.mp3 | 15 ffff15.mp3 |
| 4 aaaa04.mp3 | 10 cccc10.mp3 | 16 gggg16.mp3 |
| 5 aaaa05.mp3 | 11 dddd11.wma | 17 gggg17.mp3 |
| 6 aaaa06.mp3 | 12 dddd12.wma | |

● Display while the player is stopped

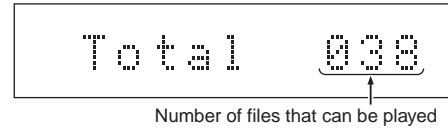

- The dotted lines with arrows indicate the playback order of files and folders.
- If there are any MP3/WMA files located immediately below the root directory, i.e. that are not in folders, they will be played before the folder files.
- The playback order will depend on the folder names and file names with the order of precedence being: numbers → alphabet upper case → alphabet lower case.
- Album 01 - Album 10
The CD-ROM example illustrated in the diagram has 10 albums (folders); however, the files in Album 05 and Album 06 are not MP3/WMA files, so will not be played.
- AAAA01.mp3 - gggg17.mp3
The CD-ROM in the example illustrated in the diagram has 17 MP3/WMA files, the first to play will be "AAAA01" and the last file to be played will be "gggg17."
- It is possible that the playback order will be different than that of the order displayed on a personal computer. This order can also change according to the CD writing software used.

■ Displaying text information

Each time the TEXT button on the remote control is pressed, the display will change in the order shown below. During playback, mainly information about the file currently playing will be displayed.

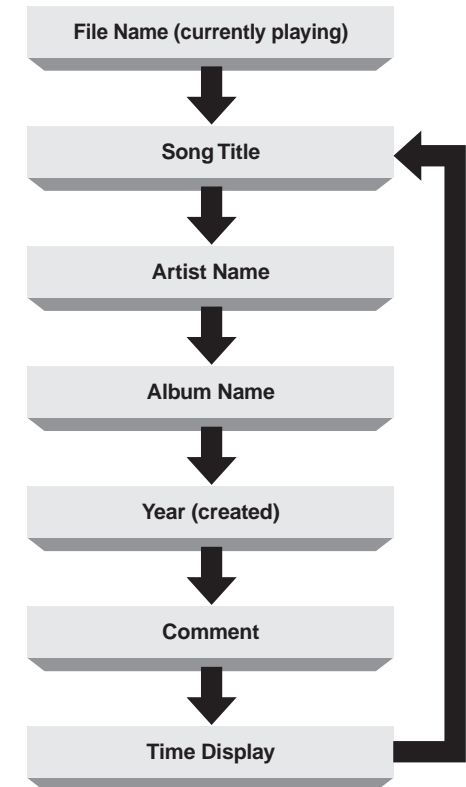

- Depending on the MP3 or WMA file being played, information may not be displayed.
- Items that have no recorded display information will be skipped.
- Only alphanumeric characters can be displayed.
- When a CD is not playing, only the number of files on the disc that can be played will be displayed.

ADVANCED OPERATIONS – MP3, WMA FILES –

MP3/WMA PLAYBACK MODE SELECTION

The playback mode for MP3/WMA files can be selected.

- Cont. mode:** All playable files on the disc will be played (When first purchased).
- Folder mode:** All playable files in a selected folder will be played.

- During stop, press the MENU button on the remote controller once then the **■** button twice. "MP3/WMA Mode" will be displayed.

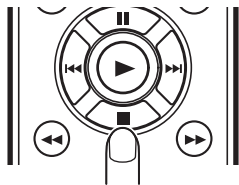
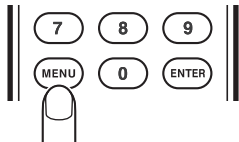

MP3/WMA Mode

- Press the remote control ENTER button. The currently set mode will be displayed.

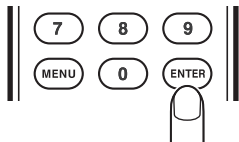

Mode : Cont.

Or

Mode : Folder

- When the **◀◀/▶▶**, **▶▶/▶▶** button on the CD player or the **◀◀**, **▶▶** button on the remote control is pressed, the display will switch.

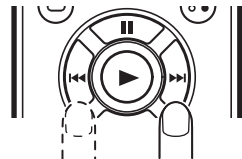

Press the remote control ENTER button to select.

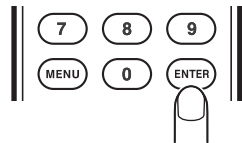

The process is cancelled if the STOP button on the player, or the STOP or CANCEL button on the remote control, is pressed.

Note:

Normal or random playback, AMS play will play the files set by the MP3/WMA playback mode.

PLAYING MP3/WMA FILES

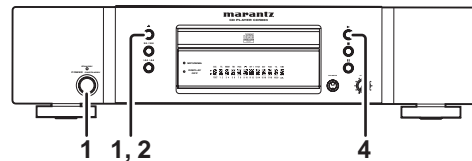

- Press the POWER button on the player to turn on the power.
- On closing the disc tray, after "TOC Reading" has displayed, the number of files that can be played will be displayed.
- Press the **▶** button on the player or remote control unit to start play. Adjust the volume level at the amplifier.

Pausing or stopping playback or CD removal are carried out in the same way as with an Audio CD. (page 10)

● Display during playback

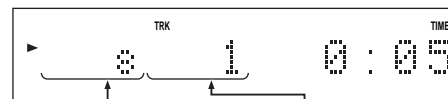

Folder number currently playing

File number currently playing

● Display while the player is stopped



The number of files that can be played

Note:

There are certain playback functions, such as program playback and pitch control, that cannot be used when MP3 and WMA files are being played back.

SELECTING THE FOLDER TO LISTEN TO

- While not playing, select the folder using the + or - buttons on the remote control.

The folder name will be displayed.

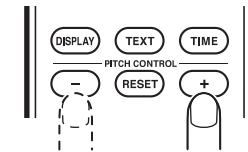

- Press the ENTER button on the remote control. The first file name in the folder will be displayed.

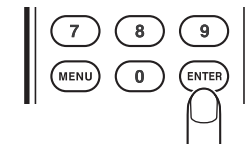

ADVANCED OPERATIONS – MP3, WMA FILES –

PLAYING A SPECIFIC FILE

Advancing to a subsequent file

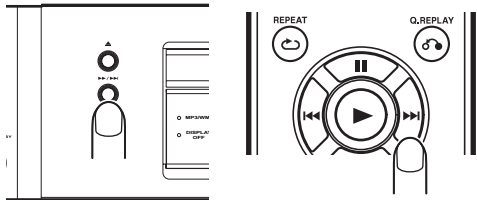

Press the ►►/►► button on the player or ►► button on the remote control unit for the number of times equivalent to the number of files through which play is to be advanced.

Returning to the start of the file now playing or a previous file

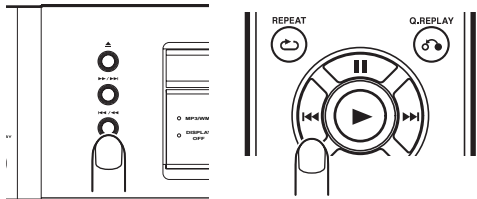

When the ◀◀/◀◀ button on the player or ◀◀ button on the remote control unit is pressed, play returns to the start of the file now playing. Play returns to the previous file which is equivalent to the number of times the button was pressed.

PLAYING A SPECIFIC PART OF A SPECIFIC FILE

While listening to a file being played, it is possible to search a specific part of that file by a forward or backward search.

Forward searching through the file now playing

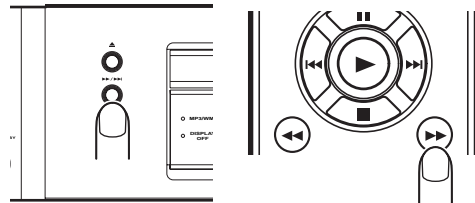

The search (forward search) mode is established by holding down the ►►/►► button on the player or ►► button on the remote control unit. Holding down the button initiates a forward search.

Backward searching through the file now playing

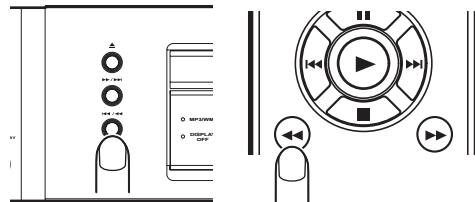

The search (backward search) mode is established by holding down the ◀◀/◀◀ button on the player or ◀◀ button on the remote control unit. Holding down the button initiates a backward search. (Returns during backward searches are not constant.)

REPEAT PLAY (PLAYING THE SAME FILES REPEATEDLY)

Playing all files repeatedly (all-file repeat)

This function repeatedly plays all the files.

Press the REPEAT button on the remote control unit.

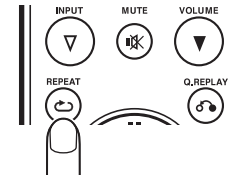

The "RPT" indicator on the display lights, and the repeat play of all the files starts.

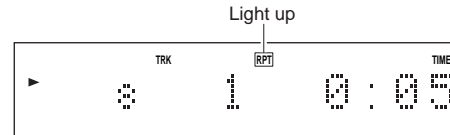

To stop all-file repeat play and resume normal play, press the REPEAT button on the remote control unit third times. The "RPT" indicator on the display goes off.

Repeatedly listen to the contents of one folder (Folder Repeat)

Repeatedly plays all the files in a folder. Press the REPEAT button on the remote control twice.

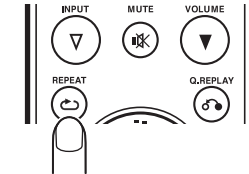

"RPT" will flash in the display window and all the files in the folder will play repeatedly.

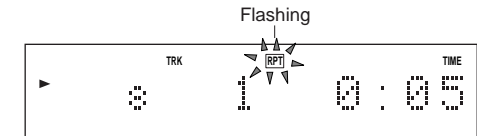

To stop Folder Repeat and return to normal playback, press the REPEAT button on the remote control twice. The "RPT" indication will disappear from the display window.

ADVANCED OPERATIONS – MP3, WMA FILES –

■ Playing one file repeatedly (1-file repeat)

This function repeatedly plays one file only. Press the REPEAT button on the remote control unit third times while the file to be repeated is playing.

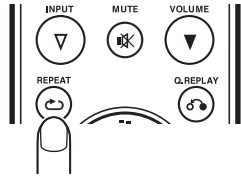

The "RPT" and "1" indicators light, and file now playing is repeated.

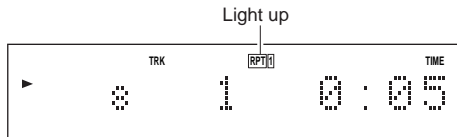

To stop 1-file repeat play and resume normal play, press the REPEAT button on the remote control unit to turn off the "RPT" indicator on the display.

■ Playing a specific part repeatedly (A-B repeat)

This function repeatedly plays a specific part of a file that you want to hear.

1. During play, press the A-B button on the remote control unit at the start point of the part to be repeated.

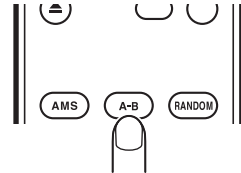

The "A-" indicator on the display now lights.

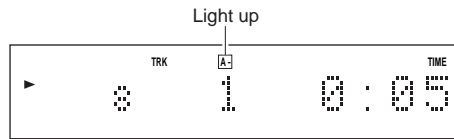

2. Press the A-B button on the remote control unit at the end point of the part to be repeated.

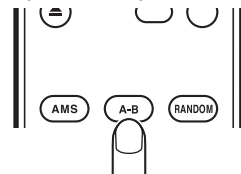

The "A-B" indicator on the display now lights, and the designated part (from point A to point B) is played repeatedly.

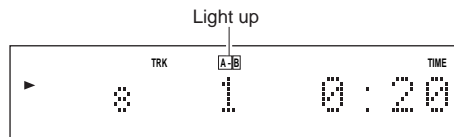

To stop A-B repeat play and resume normal play, press the A-B button on the remote control unit to turn off the "A-B" indicator on the display.

Note:

- The A-B repeat play function cannot be used during random play.
- There are cases in which difficulties will be experienced, when setting the B point, if the file's bit rate is low.

RANDOM PLAY (PLAYING FILES IN A RANDOM SEQUENCE)

This function rearranges the files into a random sequence and it then plays all the files in this random sequence. If it is used together with repeat play, the same files can be repeatedly played but in a different sequence every time.

During play or stop, press the RANDOM button on the remote control unit.

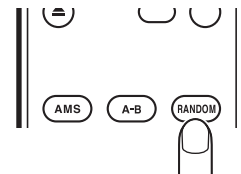

The items on the music calendar appear on the display one after the other, and the "RNDM" indicator lights.

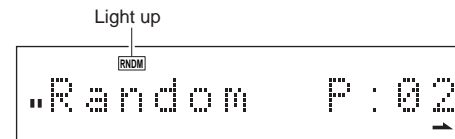

Random play now starts.

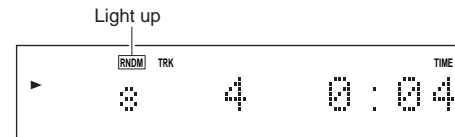

To stop random play and resume normal play, press the RANDOM button on the remote control unit. The "RNDM" indicator on the display goes off.

■ Skipping files during random play to search other files

When the >>>/>>> button on the player or >>> button on the remote control unit is pressed during random play, the next file is selected at random and played.

Conversely, when the <<</<<< button on the player or <<< button on the remote control unit is pressed during random play, play returns to the start of the file now playing.

Note:

The selected files will be played in accordance with the MP3/WMA playback mode (page 26).

ADVANCED OPERATIONS – MP3, WMA FILES –

AMS PLAY (SEARCHING FOR A SPECIFIC FILE)

All track intros, from the first track onward, are played back in sequence, which is useful when searching for a desired track.

You can choose whether to play 10, 20 or 30 seconds of each file.

During stop or play, press the AMS (auto music scan) button on the remote control unit.

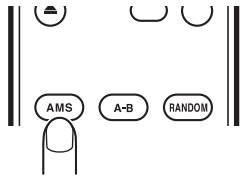

Press the AMS button repeatedly to switch through the different scan modes.

"Scan 10", "Scan 20", "Scan 30", "Scan Off"... (Scan Off aborts the scan function) light on the display, and the "▶" indicator flashes.

Flashes

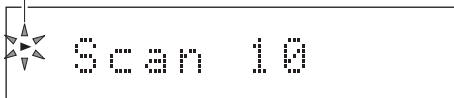

The intros of all the files starting from file 1 are played in succession for the duration which has been select. (10 sec. when first purchased)

Flashes

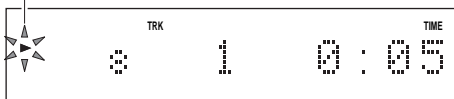

Once the file you want to hear has been found, press the ▶ button. The "▶" indicator now lights, and the file found and whatever comes after that file will now be played normally.

When the RANDOM button on the remote control unit is pressed during AMS play, the AMS play function is released, and the random play mode is established.

Note:

The selected files will be played in accordance with the MP3/WMA playback mode (page 26).

TROUBLESHOOTING

In a case of trouble, check the items below. Incorrect operations can sometimes be taken for trouble and malfunctions. If the trouble persists even after the following points have been checked, consult your dealer or nearest Marantz sales office or service center.

Symptoms	Causes	Action
A disc does not rotate.	The power cable is not plugged in.	Plug the power cable into an AC outlet. (page 9)
	The power to this unit is not turned on.	Turn on the power to the unit. (page 10)
	The disc is not placed correctly.	Place the disc correctly. (page 10)
	The disc is placed upside-down. (The label of the disc is facing down.)	Place the disc correctly. (page 10)
	The disc is dirty.	Clean the recorded side of the disc. (page 33)
	The disc is scratched.	A disc with many scratches may not be playable. (page 33)
	The disc is warped.	A warped disc may not be playable. (page 33)
The disc rotates, but there is no sound output.	An amplifier or speakers are not connected correctly.	Connect the cables correctly. (Refer to User Guide supplied with the amplifier.)
	The power to the amplifier is not turned on.	Turn on the power to the amplifier. (Refer to User Guide supplied with the amplifier.)
	The function or the selector switch of the amplifier is not set to "CD" or "AUX" (according to your current connection setup).	Set the function or the selector switch of the amplifier to "CD" or "AUX" (as per your connection setup). (Refer to User Guide supplied with the amplifier.)
	The volume of the amplifier is set to minimum.	Adjust the volume of the amplifier. (Refer to User Guide supplied with the amplifier.)
The disc stops rotating.	The disc is dirty.	Clean the recorded side of the disc. (page 33)
	The disc is scratched.	A disc with many scratches may not be playable. (page 33)
	The disc is warped.	A warped disc may not be playable. (page 33)
	The disc to be played is not a music CD. Or MP3/WMA files are not recorded on the disc.	A CD-ROM for a computer cannot be played. (page 32)

Symptoms	Causes	Action
The remote controller cannot be operated.	The distance between the unit and a remote controller is too great.	Use the remote controller nearer the unit, within the operational range. (page 4)
	Some object is placed between the unit and remote controller.	Remove the object. (page 4)
	The batteries in the remote controller are exhausted.	Replace all the batteries with new ones. (page 4)
	The remote sensor of the unit is exposed to strong light.	Avoid exposing the remote sensor to the strong light. (page 4)
A CD-R/CD-RW disc cannot be played.	The disc is placed upside-down.	Place the disc correctly. (page 10)
	The recorded information is not in a music (CD-DA) format. Or MP3/WMA files are not recorded correctly.	Record correct data appropriate for the unit. (page 32)
Pitch control operation cannot be performed.	The unit is not set to Audio EX OFF.	Set the unit to Audio EX OFF. (page 24)
Digital signals are not output.	Digital output is set to OFF.	Set digital output to ON. (page 24)
	Audio EX is set to Audio EX2.	Set Audio EX to Audio EX1. (page 24)
	Audio EX is set to Audio EX OFF, and the pitch control is used.	Set the pitch control setting to O. (page 21) Or set Audio EX to Audio EX1. (page 24)

OTHERS

■ Specifications

Audio characteristics

Channels	2 channels
Frequency response	2 Hz to 20 kHz
Dynamic range	100 dB
Signal-to-noise ratio	110 dB
Channel separation	110 dB (1 kHz)
Harmonic distortion	0.002% (1 kHz)
Wow & flutter	Precision of quartz
Audio output	2.25 V rms, stereo
Headphone output	18 mW/32 ohms (variable maximum)
Digital output	
Coaxial output (pin jack)	0.5 Vp-p, 75 ohms
Optical output (square optical connector)	-19 dBm

Optical readout system

Laser	AlGaAs semiconductor
Wavelength	780 nm

Signal system

Sampling frequency	44.1 kHz
Quantization	16-bit linear PCM

Power supply

U version	AC 120 V 60 Hz
Power consumption	14 W
Standby power consumption	0.4 W

Cabinet, etc.

Accessories	
Remote controller	1
AAA batteries	2
AC power cord	1
Audio connecting cord	1
Remote control connecting cord	1
Maximum outer dimensions	
Width	17-3/8 inches (440mm)
Height	4-1/8 inches (104.5mm)
Depth	13-3/8 inches (339.5mm)
Weight	5.1kg
Allowable operating temperature	+5 to +35°C
Allowable operating humidity	5 to 90% (no condensation)

This player's specifications and exterior are subject to change without notice for improvements.

■ Dimensions (unit: inch (mm))

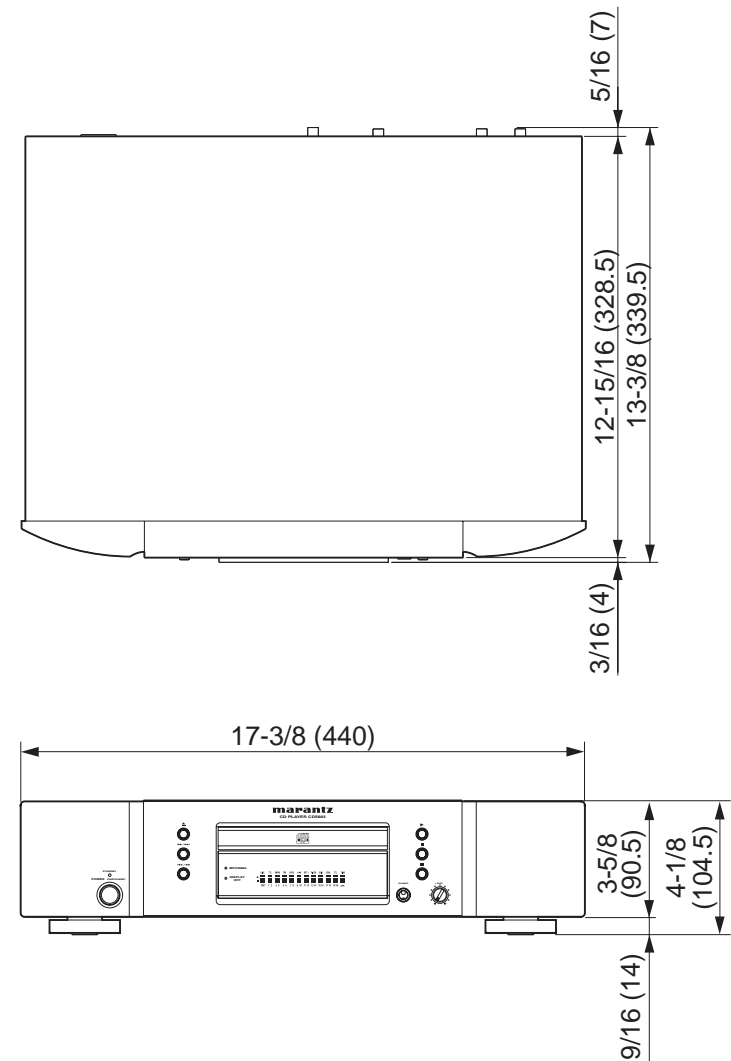

CLASS 1 LASER PRODUCT
 LUOKAN 1 LASERLAITE
 KLAS 1 LASERAPPARAT

OTHERS

■ Playing CD-R/CD-RW discs



This unit can play back the CD-RW (ReWritable) discs as well as ordinary Audio CD and CD-R (Recordable) discs.

- This unit can play back Audio CD format and CD-R/CD-RW discs which contain MP3 music data. However, some discs may have problems such as unable to play, noise or sound distortion.

* For details, please read the instruction manual provided with a CD recorder.

- The CD-R and CD-RW discs should contain properly-recorded TOC information so that they can be played back. In CD recorders, the task of writing TOC information is referred to as finalizing the disc. Discs that are not finalized cannot be properly recognized as an Audio CD and played back by regular CD players and Super Audio CD players. For details, please read the instruction manual provided with a CD recorder.

* TOC stands for Table Of Contents and contains information such as the total number of tracks and total playing time of the disc.

- This player can only be used to play Audio CD-DA format discs or discs on which MP3 or WMA audio data have been recorded. Do not attempt to play a disc containing other data, such as a CD-ROM for PCs, on this unit.
- As the playback of a CD-RW disc necessitates partial change of the player setup, it may take longer time for reading the TOC information than when an Audio CD or CD-R disc is played.

■ Playing MP3 or WMA files

This CD player can be used to play CD-R or CD-RW discs on which MP3 (MPEG Audio Layer-3) or WMA (Windows Media Audio) format audio files have been recorded.

Support for MP3 ID3 tags enables display of ID3 information, such as artist names, album titles, track titles and the like, if this information has been recorded with the tracks.



- Windows Media and the Windows Logo are the registered trademark and trademark of Microsoft Corporation in the United States and other countries.
- Music that you have recorded that is subject to copyright laws is for personal use only, and cannot be used otherwise without the permission of the copyright holder.

Caution:

- The sound file specification supported by this CD player is "MPEG-1 Audio Layer-3" (sampling frequency fs 32 kHz, 44.1 kHz, 48 kHz). Other specifications, such as MPEG-2 Audio Layer-3, MPEG-2.5 Audio Layer-3, MP1 or MP2 are not supported.
- Generally the higher the bit rate, the higher the sound quality.
MP3 bit rates are between 32 - 320 kb/s and for WMA between 64 - 160 kb/s. It is recommended that MP3/WMA recordings with a bit rate of at least 128 kb/s be used.
- Ensure that MP3/WMA files have the extension ".mp3" or ".wma." Files with other file extensions or without any extension at all cannot be played on this player.
- Playlists are not supported.
- The maximum number of files supported on a single disc is 255 and the maximum number of folders is also 255.
- File and folder names up to a length of 32 characters can be displayed.
- This player supports MP3 ID3 tags.

- The text information, such as ID3 tag information and file names that are displayed during playback of MP3s, support English alphanumeric characters only.
- When playing variable bit rate files, it is possible that the playing time may not be displayed accurately.
- When writing onto CD-R or CD-RW discs, please use either ISO9660 mode 1 or ISO9660 mode 2-disc format. Multi-session recording is also supported enabling the playing of data that have been added to a disc.
- MP3/WMA files that have been recorded by "packet writing" cannot be played back.
- Depending on the condition of the recorded data, it may take some time to read song information.
- In the case of an Enhanced or Mixed Mode CD having combined audio format CD-DA along with MP3/WMA files, only the CD-DA audio portion will be played.
- The playback of WMA DRM (Digital Rights Management) files is not supported by this player.

OTHERS

Notes about the discs

- * Handle the discs carefully so as not to scratch their surfaces.

- * Keep the surfaces of the discs clean at all times.

When cleaning the surfaces of discs, always be sure to use the special cleaner and wipe the surfaces in the directions shown in the figure below.

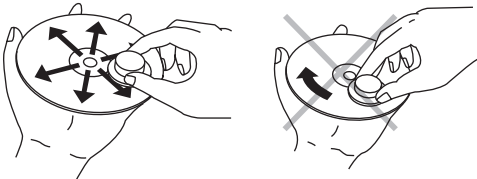

- Wipe the surface radially from the center.
- Do not wipe the surface in the circumferential direction.

- * Do not attach pieces of paper or stickers to the label surfaces of the discs.

When a disc has a piece of plastic tape or rental CD label with paste protruding from the edge or when a disc still bears traces of sticky tape or adhesive labels, do not attempt to play it. If such a disc is played on the CD player, you may find that you cannot remove it or that some other kind of malfunctioning may occur.

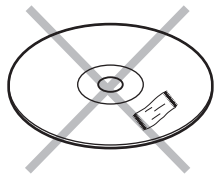

- * Do not use discs which come in special shapes.

Do not attempt to play heart-shaped or octagonal discs or discs with any other special shapes. You may find that you cannot remove them or that some other kind of malfunctioning may occur in the player.

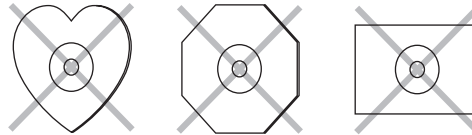

- * Use discs which satisfy the CD standards such as those with the "CD logo", "CD DIGITAL AUDIO" or "CD TEXT" mark on their disc label surfaces.

No guarantees are made for playback if discs which do not satisfy the appropriate CD standards are used.

Similarly, no guarantees are made for their sound quality even if it is possible to play such discs.

- * To protect your discs from damage, avoid placing them in the following locations.

- Where they will be exposed to direct sunlight or where they will be close to a heater or other heat-radiating appliance
- Where the humidity level is high or it is very dusty
- Near a window or other such location where they may be exposed to rain

- * Get into the habit of putting the discs back in their cases after use.

About playing copy-controlled CDs

Some copy-controlled CDs may not conform to official CD standards. They are special discs and may not play on the unit.

On playing a DualDisc

- On one side of a "DualDisc", video and audio signals conforming to DVD standards and on the other side audio signals to be played on a CD player are recorded.
- Signals recorded on the side for audio signals only (the CD side) are not in conformity with the general physical CD standards and may not be playable on this player.
- For details on the specifications and standards of a "DualDisc", refer to a dealer or distributor of the disc.

OTHERS

The section describes the care and maintenance tasks that must be performed to optimize the operation of your Marantz equipment.

■ Cleaning of equipment external surfaces

The exterior finish of your unit will last indefinitely with proper care and cleaning. Never use scouring pads, steel wool, scouring powders or harsh chemical agents (e.g., lye solution), alcohol, thinner, benzene, insecticide or other volatile substances as these will mar the finish of the equipment. Likewise, never use cloths containing chemical substances. If the equipment gets dirty, wipe the external surfaces with a soft, lint-free cloth.

If the equipment becomes heavily soiled:

- dilute some washing up liquid in water, in a ratio of one part detergent to six parts water.
- dip a soft, lint free cloth in the solution and wring the it is damp.
- wipe the equipment with the damp cloth.
- dry the equipment by wiping it with a dry cloth.



■ Using headphones

If the volume in the headphones is too high, it may injure your ears. Do not set the sound volume too high.

■ Repairs

Only the most competent and qualified service technicians should be allowed to service the factory-trained warranty station personnel have the knowledge and special facilities needed for repair and calibration of this precision equipment. After the warranty period has expired, repairs will be performed for a charge if the equipment can be returned to normal operation.

In the event of difficulty, refer to your dealer or write directly to the nearest location to you that is listed on the Marantz Authorized Service Station list. If writing, please include the model and serial number of the equipment together with a full description of what you think is abnormal about the equipment's behaviour.

www.marantz.com

You can find your nearest authorized distributor or dealer on our website.

marantz[®] is a registered trademark.

